



INTELLISPEC™

Training Guide

Inside of Can Inspection Series V | 5.6 Software

Copyright Notice / Contact Us

© 2020 Pressco Technology Inc. All rights reserved.

No part of this manual may be reproduced or transmitted in any form or by any means, electronic or mechanical, including photocopying and recording, for any purpose, without the express written permission of Pressco Technology Inc.

The contents of this manual are furnished for informational use only, are subject to change without notice, and should not be construed as a commitment by Pressco Technology Inc.

Written and designed at:

Pressco Technology Inc. World Headquarters

29200 Aurora Road

Cleveland, OH USA 44139-1847

TEL +1-440-498-2600

FAX +1-440-498-2615

www.pressco.com

Business Hours: Monday - Friday, 8:00am - 5:00pm Eastern Time

Customer Support:

24/ 7 Customer Support (for urgent system help): +1-440-498-2000

e-mail: Schedule a service visit: dispatch@pressco.com

Request technical support and remote support: techsupport@pressco.com

Customer Service Fax: +1-440-498-4761

Table of Contents

Pressco Introduction 1

 Inspection Terminology 1

 Sequence of Events During Inspection 2

Hardware Overview 3

 Intellispec Cabinet and User Interface 3

 Computer Internal Components 4

 UPS Information 5

 Chromapulse Module 6

 Light Tree 7

 Part Tracker Board 8

 How to start up the Intellispec system 9

 How to shut down the Intellispec system10

Software Overview11

 4 Software Screens11

 System Overview screen 11

 Lane Overview Screen12

 Sensor Overview Screen12

 Inspection Overview Screen13

 Menu Toolbar14

 Tools menu - System Overview Screen16

 Help17

 User Accounts & Login17

 Log in and log out18

- Log In menu 19
- Manage Users 20
- Add a user with the biometric login device 21
- Export Users 23
- Import Users 24
- Set Up Auto Logout 25
- System Tools 27
 - Log Reader 27
 - Reporting 28
 - Lane Summary and Lane Detail reports 29
 - Correlation Report 30
 - Schedule Reports 31
 - Alarms 35
 - View and Clear Alarms 36
 - View and Clear Machine Part Alarms 37
 - System Alarms - Description and Configuration 39
 - Lane Alarms - Brief Description 41
 - Lane Alarm Configuration 42
 - Sensor Alarms - Brief Description 47
 - Sensor Alarm Configuration 49
 - Rejector Alarms - Brief Description 54
 - Rejector Alarms Configuration 55
 - Machine Part Alarms - Brief Description 58
 - Machine Part Alarms Configuration 60

All Alarms	63
Exclamation Sign or Warning Displayed on Alarms Button	66
Rejecting	66
Reject Enable/ Disable for Multiple Sensors within a Lane	67
Reject Enable/ Disable for Sensor Only	69
Forced Rejects Utility	71
System Tools	71
Machine Part Correlation	72
Support Package	74
Create a Support Package	75
Restore From Support Package	78
Save Images	78
Save Images Through the Sensor Menu	81
Auto-Save Images	82
Save Images through the Retro-Spec interface	84
Save Individual Images While Editing an Inspection	87
Save Reject Images	88
Save a Region of Interest (Unwrapped) Image	89
Loading Saved Images	90
Lighting and Imaging	91
Pressco Inspection Theory	91
Introduction to Pressco Inspections	92
Pixel Grayscale Values	93
Examples of Grayscale	94

- Gradient 95
- Delta 96
- Size 97
- Part Tracker Simulation 97
- Imaging 98
 - Offline Imaging 99
 - Image Analysis 100
- Lighting 102
 - Lighting - access 103
 - Basic Adjust Lighting 104
 - Advanced Adjust Lighting 106
- Part Tracking 109
 - Sequence of Events During Inspection 109
 - Part Tracking Terminology 109
 - Encoder 110
 - Encoder/ PDX "Timing Wheel" 110
 - Part Tracking Using a PDX 111
 - Part Width Calibration 112
 - Part Present Delay Calibration 114
 - Reject Delay and Dwell Calibration 115
 - Adaptive Reject Calibration (optional) 115
 - Reject Confirm Calibration (optional) 117
 - PDX Configuration 118

Part Width Calibration using PDX	121
System Maintenance and Troubleshooting	123
Maintenance Frequency with Chromapulse Modules	123
Cleaning the Vision Processor Filter	125
Cleaning the Part Detector and Reflector	127
Cleaning the Camera Lens	128
Cleaning the Chromapulse Beam Splitter	129
Cleaning the Ellipsoidal Mirror	131
Cleaning or Replacing the Chromapulse Fan Filters	132
Replacing Filter-Regulator filters	133
Troubleshooting Tools and Information	134
Camera LED Indicators	135
Help - Remote Support	136
Exiting the Intellispec software	139
Discovery Software - What is Discovery?	140
Discovery software screen	141
Discovery Menu Toolbar	142
Part Programming	143
Part Changeover	143
Manage Part Programs	143
Create, Copy, or Import a Part Program	144
Inspection Overview	146
Inspection Terminology	147
Icon or Symbol Options (Sensor Menu)	148

Inspection Tree Configuration	150
Inspection menu	151
Reject Enable/ Disable for Sensor Only	154
Reject Enable/ Disable for Multiple Sensors within a Lane	156
Edit Regions	158
Edit Inspections	159
Edit Parameters	160
Result Options	162
Retro-Spec Display	163
Retro-Spec Population View	164
Retro-Spec Part View	166
Inspection Tree Relationships	168
Part Program Change Log	169
Optimize	170

Pressco Introduction

Welcome!

Congratulations on your purchase of an Intellispec system! The Intellispec is a high-speed machine vision system designed specifically for product and online process monitoring. It is a powerful tool that provides inspection much more reliably than the human eye or sampling methods. The latest PC technology, powerful inspection algorithms, online adjustment capability, and inspection data storage allow the Intellispec to automatically inspect parts with extreme accuracy on high-speed lines.

The Intellispec will help you provide the highest quality of products shipped to your customers.

Inspection Terminology

Analysis Analyzes the pixel shade information within a region and compares it to reference values. The inspection passes or fails based on these comparisons. There are also several analyses that make measurements. You may have many analyses for each inspection region.

Dimension The dimension inspection type connects the results of two other inspections to do the analysis. For example, a distance inspection can connect two registrations to measure the distance between centers of two features.

Enhancements Enhancements are used to alter images for better defect detection, or for making certain features stand out.

Inspection Module The housing, camera, cables, and associated electronics that are installed on or over the production line to acquire an image of your product. Sometimes referred to as a tunnel. The inspection module can have a different sensor than a camera to make measurements of your product (example: Intellimass sensor).

Lane A lane usually refers to one production line, and can contain multiple sensors.

Orientation An orientation compensates for part rotation by finding a grayscale pattern. An analysis which must rotate with the part must follow an orientation.

Part Program The list of regions, analyses, registrations, etc. programmed specifically for your part to detect defects or make measurements.

Part Tracking refers to the monitoring of parts from the part detect sensor to reject station. This ensures that the correct parts are rejected at the correct time, and that good parts remain in the part stream.

Region The Region indicates where on the part the analyses will take place. You may have as many inspections as you like in one region.

Hardware Overview

Intellispec Cabinet and User Interface

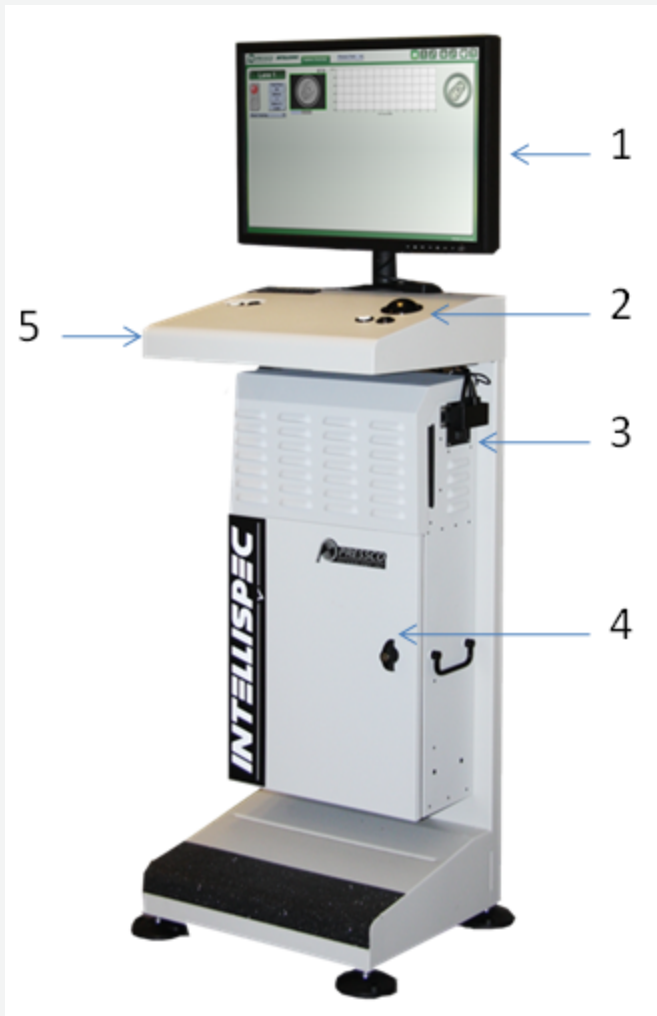

1 - 24" Diagonal color LCD with optional touch screen. An on-screen keyboard (OSK) is displayed when needed.

2 - Trackball with two sets of buttons (left-handed or right-handed): Select buttons [✓] and Information buttons [i]

3 - Vision processor on/off switch.

4 - Inside the cabinet: Ethernet switches, Vision processor, Mechanical keyboard (MKB)

5 - USB convenience port is mounted on the side of the user interface.

Computer Internal Components

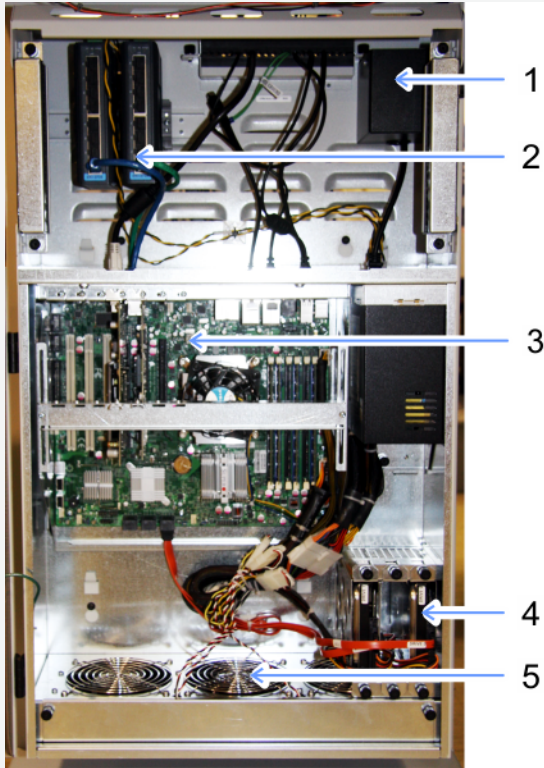

- 1 - Main power switch
- 2 - Ethernet switches (up to four switches)
- 3 - CPU/ Motherboard
- 4 - Two hard drives
- 5 - Cooling fans

UPS Information



To access the UPS:

Loosen 4 thumb screws [item 1] and lift up to remove UPS cover located on the back of the User Interface Cabinet.

UPS LED description

LINE Green LED lights continuously to indicate the utility-supplied AC line voltage at the wall outlet is OK.

BYPASS Yellow LED lights continuously when the UPS system is in economy mode. The LED flashes when the UPS system is bypass mode, indicating that the UPS system's DC/AC inverter is deactivated.

FAULT Red LED flashes when the UPS detects an internal fault.

ON LINE Green LED lights continuously to indicate the UPS system is operating normally in on-line mode.

LOAD Green LED lights when the UPS system is receiving AC power. It also indicates that the % level LEDs (25%, 50%, 75%, 100%) are displaying the UPS load level.

OVERLOAD Red LED lights continuously to indicate that the UPS system's capacity has been exceeded. The UPS alarm beeps continuously.

% Level These dual-function LEDs indicate the % level for either the load level (if the "LOAD" LED is lit) or the battery charge level (if the "BATT" LED is lit).

BATT Green LED lights when the UPS system is operating from battery power.

ON BATT Green LED lights continuously to indicate that AC line voltage is absent. The UPS system also beeps every 2 seconds, unless you press the ON/TEST button to silence it.

BATT LOW Yellow LED lights when the UPS system's battery charge level is low. The UPS alarm beeps until the batteries are either depleted or adequately recharged.

REPLACE BATT Red LED lights continuously and the UPS alarm beeps every 2 seconds if the UPS system fails the automatic self-test.

Chromapulse Module

Depending on the size of the part and specific defects, the module could be a small CP300 up to a large CP1500. The modules show below are CP750E, CP4422E, and CP1200EV2.



Light Tree

The lights on the optional light tree will turn on, off, or blink depending on status of certain hardware. Each lane has its own light tree.

Note: the light tree on your system may look different than the picture shown

	Light color	Condition	What it means
	Red	On - steady	Alarm condition
	Red	On - blinking	Part tracker board lost communication with the host PC or has an error and needs to initiate an alarm
	Red	Off	No alarm (OK)
	Amber	On	Warning alarm condition
	Amber	Off	No warning (OK)
	Amber	0.5 second flash	System automatically resets Asynchronous Correlation FIFO (not used in all systems)
	Green	On	Lane is online
	Green	Off	Lane is offline
	Blue	On	Part tracker board has power (OK)
	Blue	Off	Part tracker board has no power

Part Tracker Board

The part tracker board monitors parts throughout the inspection process. There are two types of part tracker boards for Pressco Series 5 systems: 2-channel and 8-channel.

A 2-channel board is shown below.

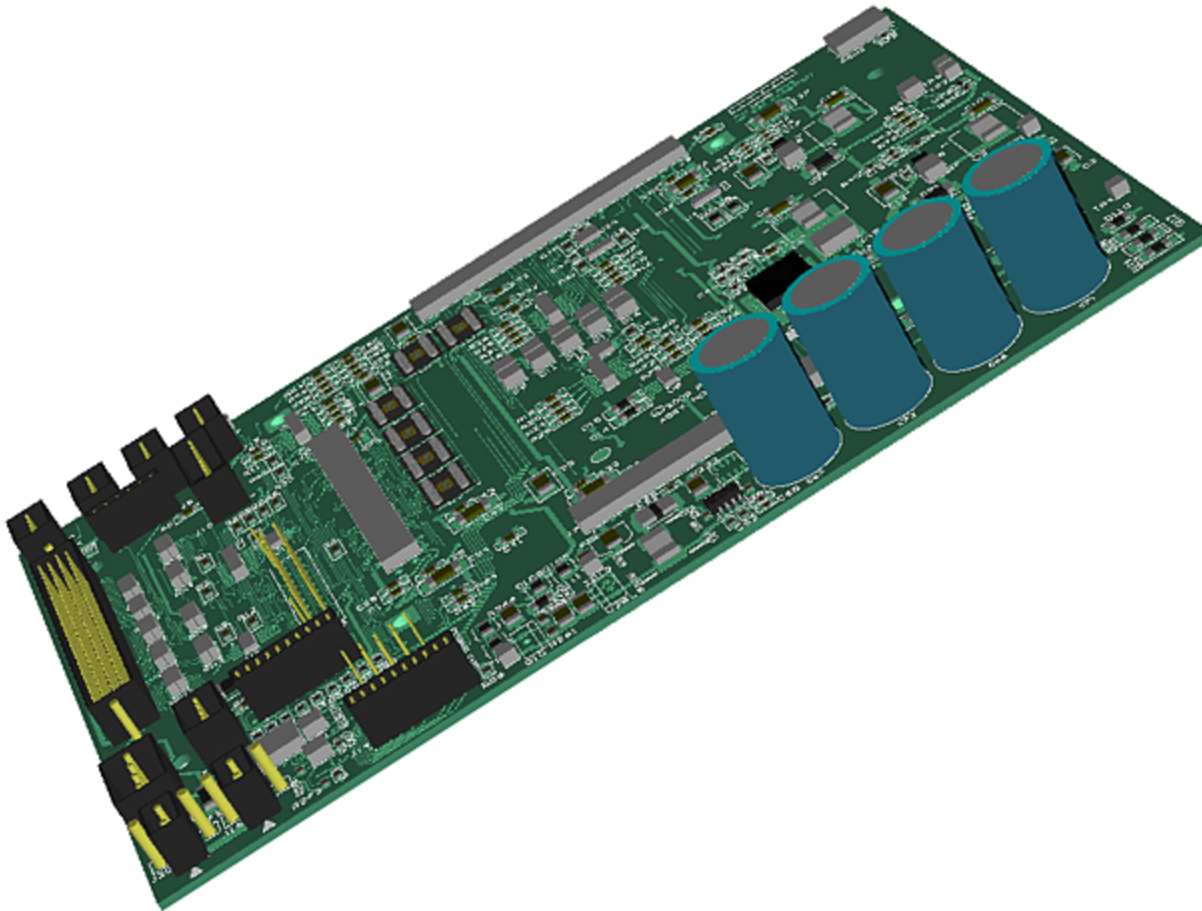

How to start up the Intellispec system

Note: you may need Operator user permission to put the Intellispec system online.

1. Turn the power switches for all Cluster Boxes (if applicable) and Modules to the ON position, in any order. All cluster boxes and modules must be powered on before proceeding.
2. Turn on the UPS (uninterruptible power supply):

Remove the cover from the back of the Intellispec pedestal by turning the thumb screws [item 1].

Press and hold the ON TEST button (of the UPS) until you hear a beep. Release the button as soon as you hear the beep.

Replace the cover on the back of the Intellispec pedestal.

1. Wait for the Intellispec software to start. This takes about 3 to 5 minutes.

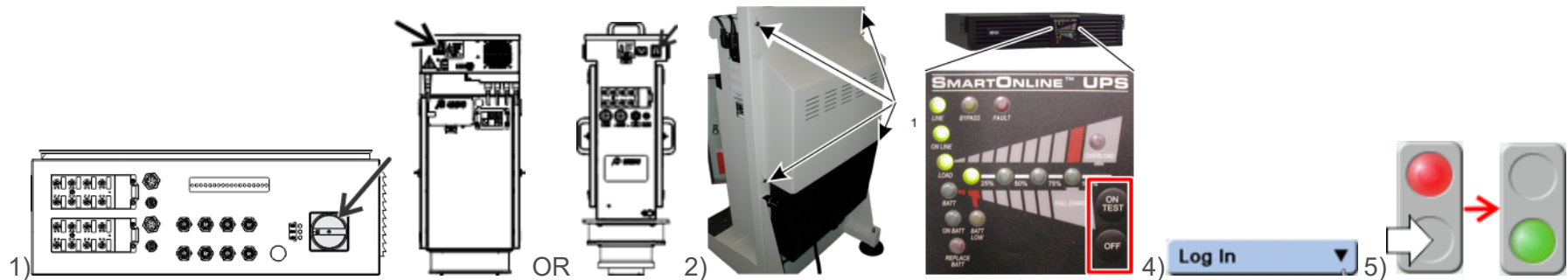

Note: Steps 4-6 only need to be completed if your system does not automatically go online after startup.

1. Log in to the Intellispec software.
2. Put the system online.
3. Log out of the system.



How to shut down the Intellispec system

NOTE: You must have Mechanic-level user permission or higher

1. Log in.
2. Take the system offline. (Repeat for all lanes if necessary)
3. Exit the software:  |  | Shut Down Intellispec and Computer.
4. After the computer shuts down, turn off the UPS (uninterruptible power supply):

Remove the cover from the back of the Intellispec pedestal by turning the thumb screws [item 1].

Press and hold the OFF button (of the UPS) for 4 seconds. You will hear a beep. Release the button as soon as you hear the beep.

1. Turn off power switches for all Cluster Boxes (if applicable) and Modules, in any order.

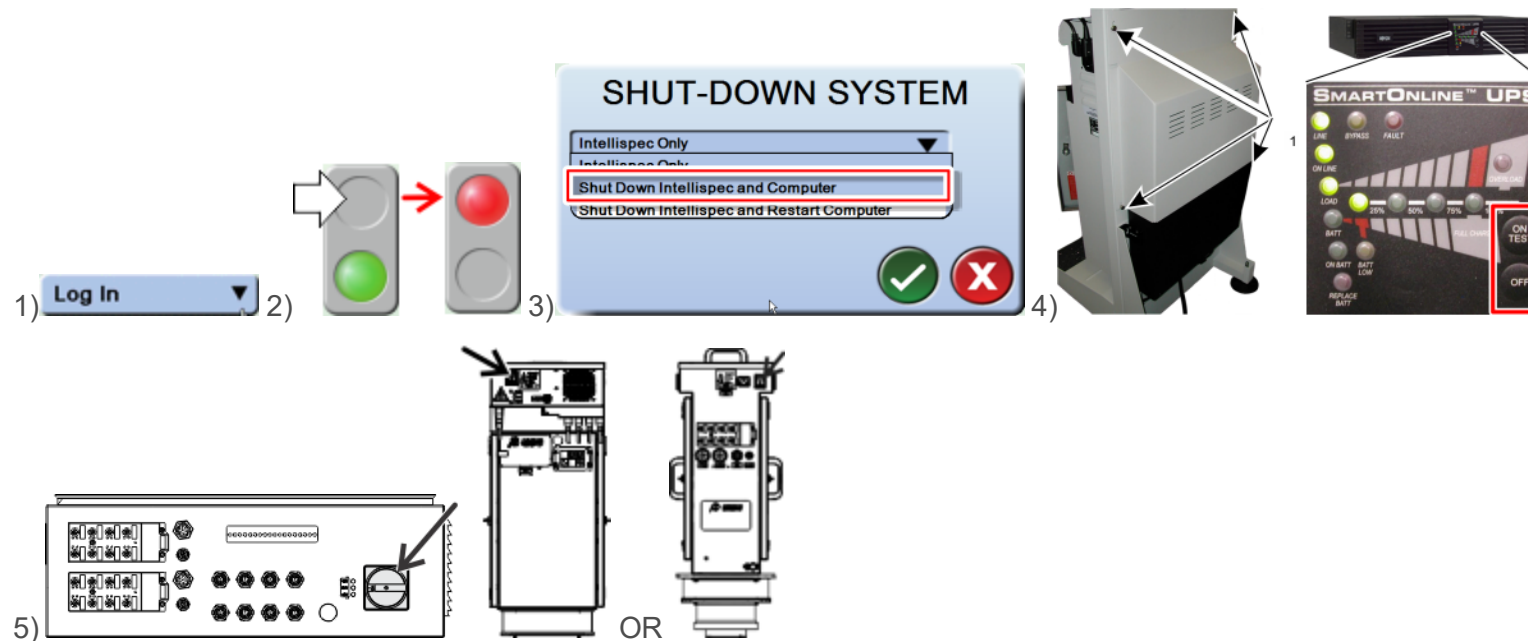

Software Overview

4 Software Screens

This section describes the four main types of screens in the Intellispec software.

System Overview screen



Access the System Overview screen by selecting the Home icon.

1 - "Menu Toolbar" on page 14

2 - Log in/ Log out.

3 - Walk-by graphic

4 - Go to Lane Overview

5 - Online/ Offline

6 - Lane Statistics

7 - Part Program

8 - Heartbeat Image

Note: your system may have multiple lanes. This example shows one lane.

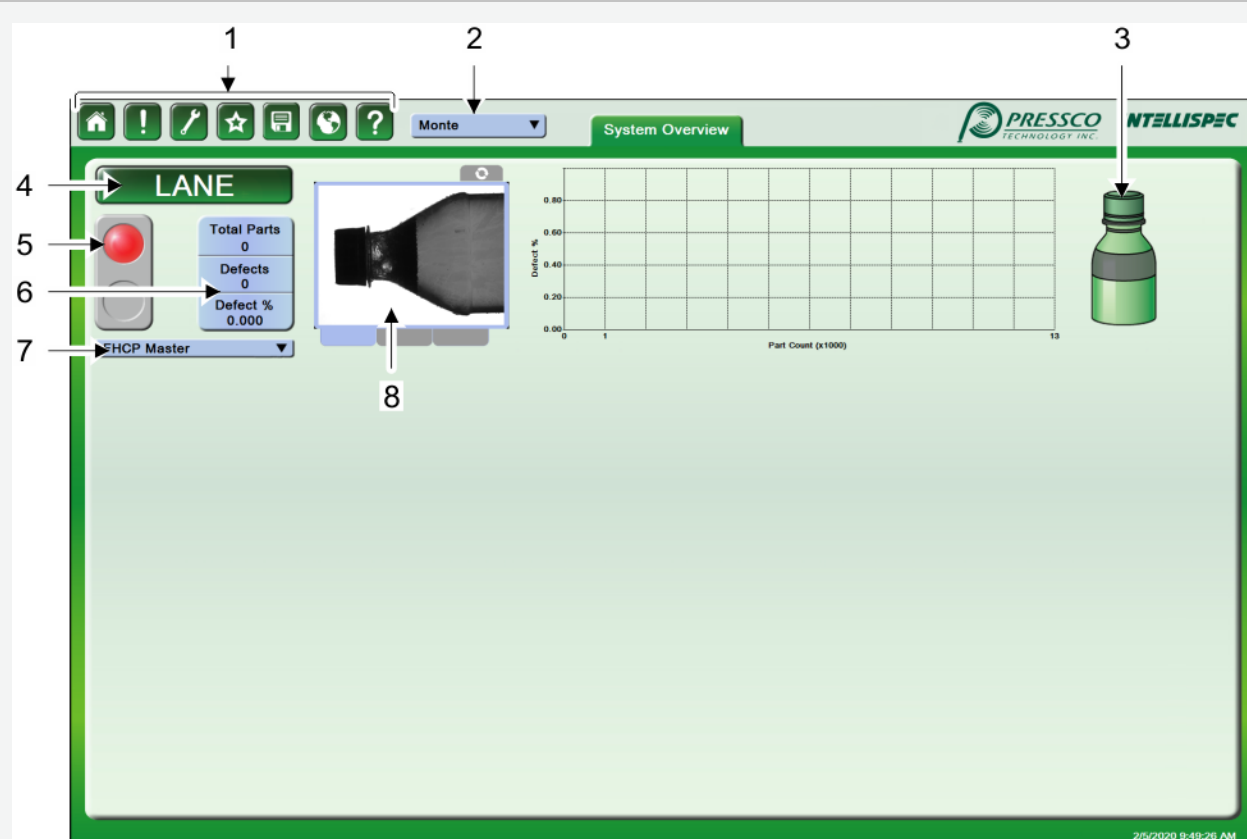

Lane Overview Screen

Lane *n* Access a Lane Overview screen by selecting a Lane button. Your system may have multiple lanes.

The screenshot displays the Lane Overview interface. At the top, there is a navigation bar with icons for home, alerts, tools, favorites, refresh, and help, along with a user dropdown menu showing 'Admin_0815'. The main dashboard features a 'BNS' section with a 'Parts' dropdown, a 'Defect %' dropdown, and a 'Lane Total' dropdown. A line graph plots 'Defect %' against 'Part Count (x1000)', with an 'Alarm level 21.775%' indicated. To the right of the graph is a green bottle icon. Below the graph are three detailed sensor views: 'Sensor 1' (7 defects, 12.500% defect rate), 'Neck' (4 defects, 7.143% defect rate), and 'Seal' (12 defects, 21.429% defect rate). Each sensor view includes a small image of the defect and a grid of larger images with timestamps. On the right side, there is a vertical menu with buttons for 'Trend Graphs', 'Machine Parts', 'Statistics', 'Reject Images', 'Cavity', 'Spindle', 'InFeed', 'OutFeed', 'Inspections', 'Statistics', 'Freeze on Defect', and 'Walk-by'. The bottom right corner shows the date and time: '10/15/2018 9:01:18 AM'.

1 - Select the sensor *n* button to toggle to detailed Sensor View and back

2 - Switch to System Overview

Sensor Overview Screen

The screenshot shows the Sensor Overview for 'Penny'. It features a small image of a penny and the following statistics: 'Defects: 98777' and 'Defect %: 20.000'.

Access the Sensor Overview by selecting a sensor button. Your system may have multiple cameras/ sensors.

2 →

1 →

Inspection Results (double click to edit)	
Inspection	Result
Empty Pocket ROI	Good
Empty Pocket	Good
Center Region	Good
Seal Center	Good
Seal Surface ROI	Good
Seal Surface Inspection	Bad
Choked Neck Region	Good
Choked Neck	Good
Ovality ROI	Good
Ovality Inspection	Good

1 - Double-click to open Inspection View

2 - Switch to System Overview

Inspection Overview Screen

Double-click an inspection name in the inspection tree to access the Inspection Overview screen. This is the screen where you may adjust inspection parameters (if you have user permission).

Two different views are available in this screen: "Retro-Spec Population View" on page 164 and "Retro-Spec Part View" on page 166

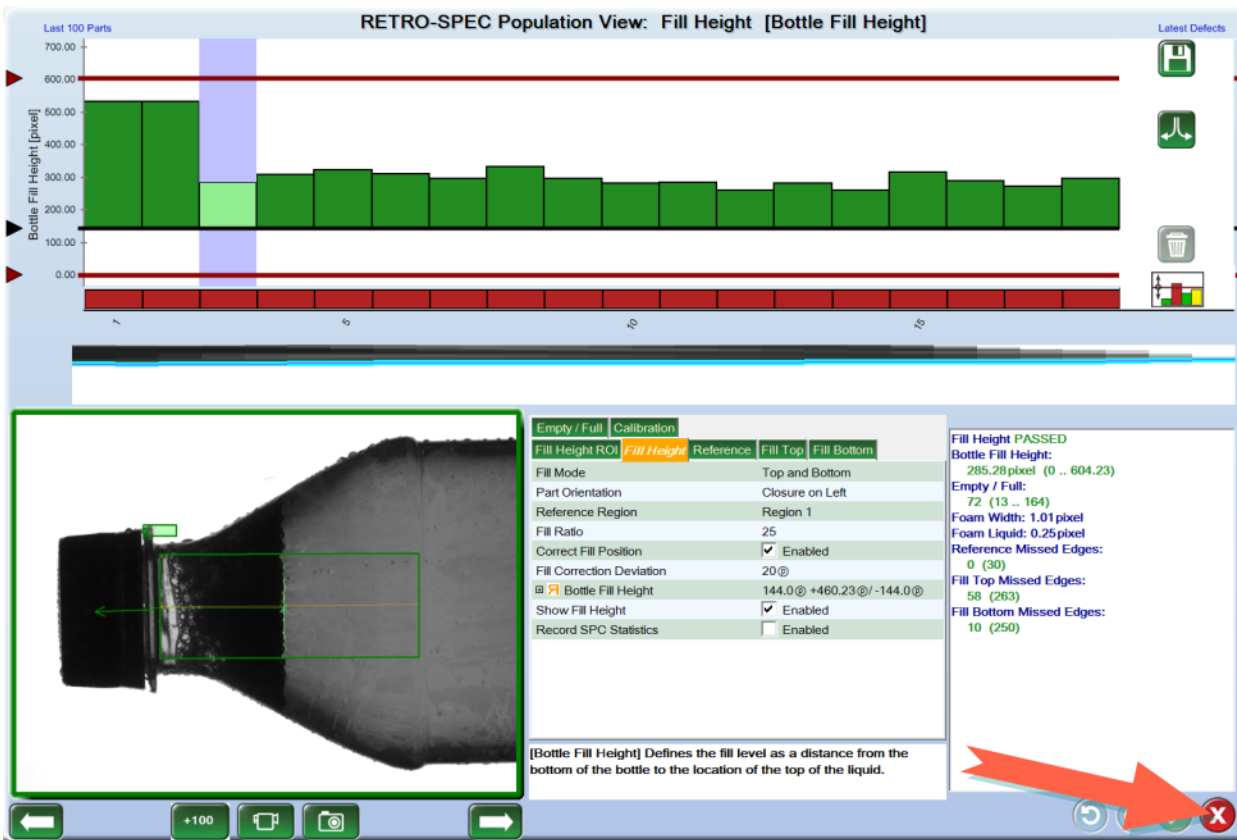

Close the Inspection View to switch to System Overview or Sensor Overview

Menu Toolbar



1 - **Home** Go to the System Overview Screen

2 - **Alarms** Clear, view, and set alarms

- 3 - **Tools menu** Configure system settings, reports, hardware, part tracking, rejectors, part setup, and more
- 4 - **Star menu** Take screen shots and manage background tasks
- 5 - **Back Up and Restore Menu** Create a support package, restore the system from a support package, and launch Windows Explorer
- 6 - **Language** Select the language to display the Intellispec software, from the available options
- 7 - **Help** Access the help documents, remote support, and determine software version

Note: some menu items change, depending whether you are in System Overview mode or Lane/Sensor Overview mode

Tools menu - System Overview Screen

To get to this menu: Select the Home button  | Tools .

Note: Some menu items are only available to advanced level users.

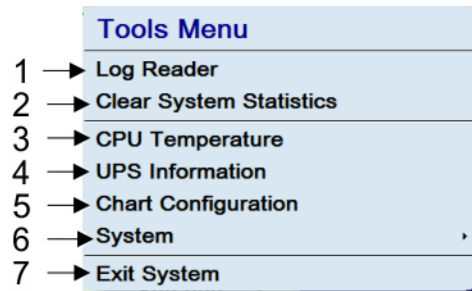

1 - **Log Reader** Open the Intellispec log (see also "Log Reader" on page 27)

2 - **Clear System Statistics** Clear the entire system statistics (all Lanes)

3 - **CPU Temperature** If a multiple core computer is used, the highest temperature is displayed. If the shutdown CPU temperature is reached, the Intellispec system shuts down.

4 - **UPS Information** Display Uninterruptible Power Supply (UPS) information and settings

5 - **Chart Configuration** Choose the Trend Graph type and the number of points for the chart in the System Overview Screen

(not shown)- **Defect Writing** [Only if Defect Database option is installed and enabled] Enable or disable defect recording for multiple lanes.

6 - **System** Set system date and time or set up a printer

7 - **Exit System** Shut down Intellispec software

Help

Select the Help icon  to:

- use the system manuals
- access Pressco "Help - Remote Support" on page 136
- obtain your current software version

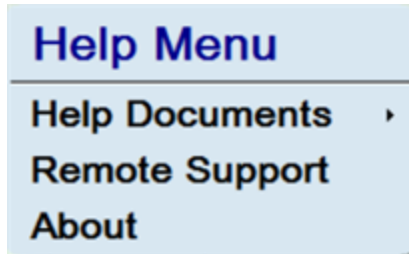

To access the user manuals:

1. Select the Help icon .
2. Select Help Documents, then select a manual from the list. The user manual is displayed.

User Accounts & Login

This section describes how to log in and how to manage user accounts.

Log in and log out

To log in, use either method:

- A.  Select the **Log In** button. Select your user name, and enter your password.
- B. With the optional **biometric sensor**: Press your finger to the sensor. The system logs you in. If the system fails to recognize your identity after three attempts, then log in through the log in dialog box.

To log out:

- A.  Select the button with your name, then select the **Log Out** button.
- B. With the optional biometric sensor: Press your finger to the sensor. The system logs you out.

Note: When another user logs in, the system automatically logs you out.

Log In menu

To ensure that only authorized users perform certain changes to the system, users are required to log in.* Some of these menu items are available to advanced users only.

*Some tasks can be configured so that users do not need to log in. This is done through the **Manage Permissions** menu.

To view the Log In menu:

 Select the **Log In** button and enter your password. The text on the button changes to indicate who is logged in.

 Select the **Log In** button again. The popup menu appears.

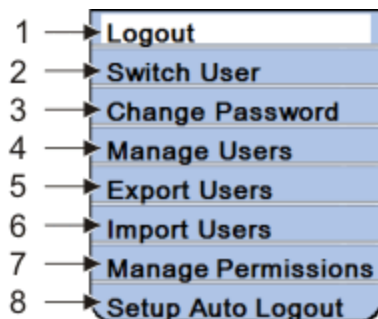

1 - Logout

2 - Switch user

3 - **Change Password** - change only your password

4 - **Manage Users** – add, remove, or edit users

5 - **Export Users** - export user profiles from one Intellispec to another

6 - **Import Users** - import user profiles from one Intellispec to another

7 - **Manage Permissions** – assign specific areas of the system that a user can access

8 - **Set Up Auto Logout** – the system logs you out if there is no activity for the specified time

Note: There is a Pressco Technician account for use only by Pressco Service Engineers. This gives access to unsupported features (menu items are a different color). If you log into this account and use those features, do so at your own risk.

Manage Users

Administrator only

Add, Edit, or Remove users. You may create one user account for a group of people (example: Shift 1).

Note: the biometric login features are only used when the optional biometric login device is installed

To manage a user account:

1. Log in as an administrator.
2. Select the button with your user name **Bob** | **Manage Users**.
3. Select **Add**, **Edit**, or **Remove** a user. Follow the information on screen to complete these actions. The current step is highlighted [item 1 in illustration].
4. Use the forward arrow button  [item 2] to move to the next screen(s).

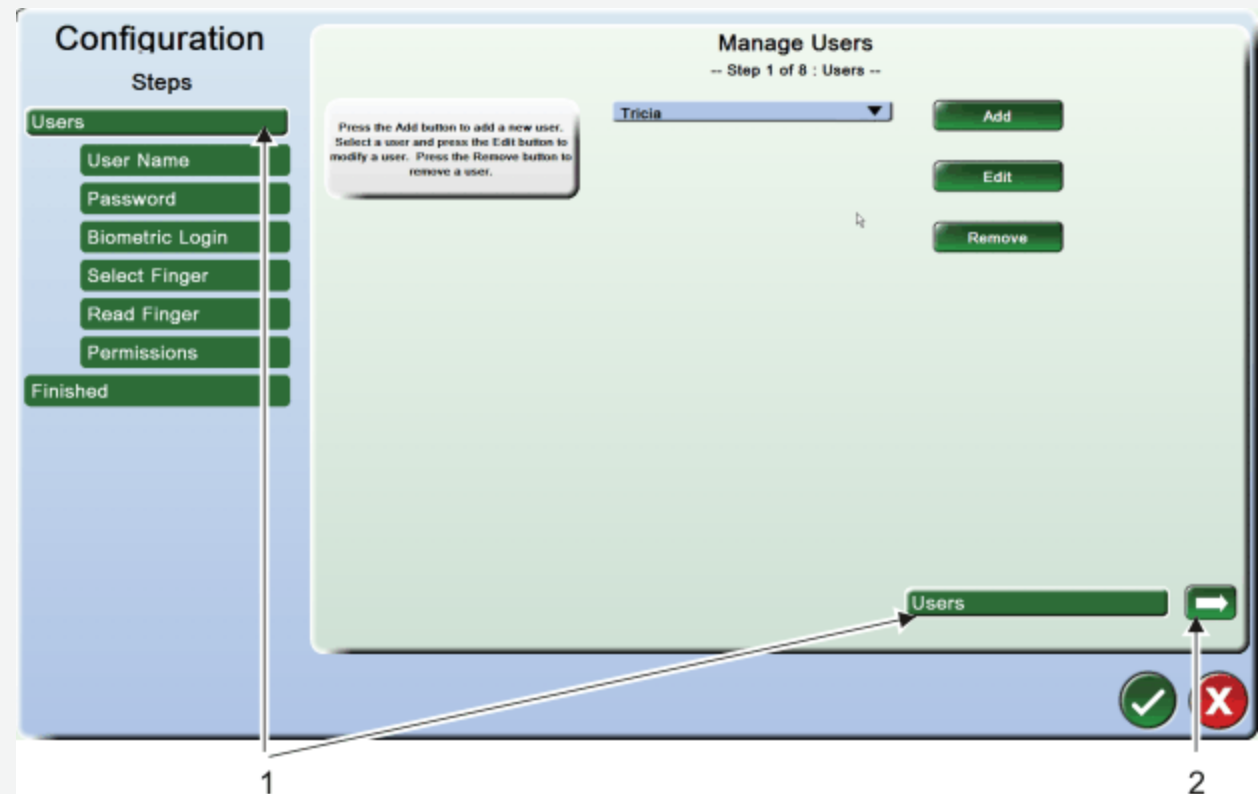



Add a user with the biometric login device

The biometric device uses finger recognition software to log in. You can always [log in](#) using your user name and password, even if you have a biometric login device. The maximum number of biometric accounts is 40.

Note: You cannot create two accounts for the same finger print. You could create two accounts for one person, but you must use two different fingers

To add a user with the biometric login device:

1. Log in as Administrator.
2. Select the button with your user name **Bob** | **Manage Users** | **Add**.
3. Add the new user name when prompted. Select the forward arrow .
4. Enter a password, then Confirm it. Select the forward arrow .
5. [Biometric login] Select **Biometric**.

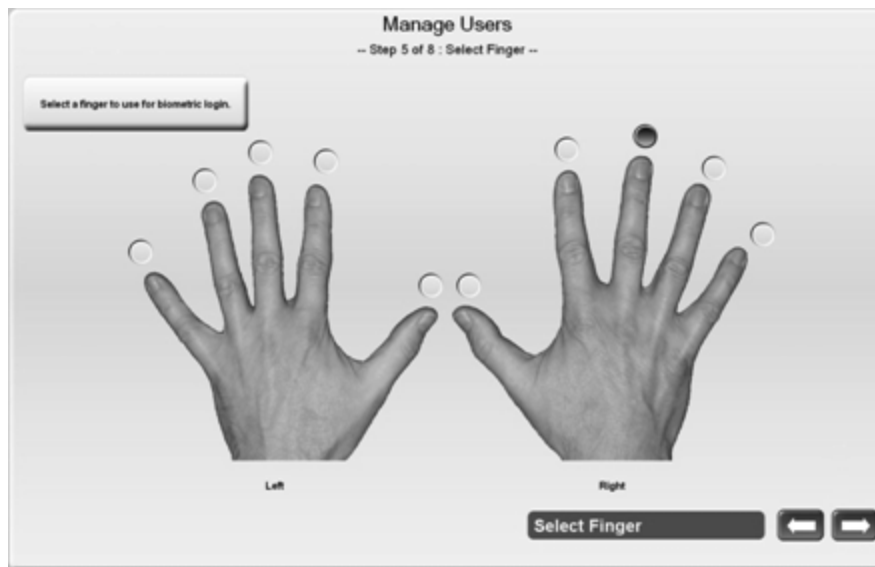

6. [Select Finger] Choose which finger the biometric sensor will read. This finger must be used every time when logging in.
7. [Read Finger] Select the **Start** button at the top of the screen. Instruct the user to place his or her finger on the biometric sensor three times (for accuracy) when prompted.

8. [Permissions] Select the desired permissions.
9. [Finished]  Select the OK button to save changes and exit.

Export Users

Export user accounts from one system to another, or back up your user accounts.



What you need:

- A USB device
- Administrator access

To export a user account:

1. Insert the USB device into an available slot on the Intellispec Series V system.
2. Select the button with your user name **Bob** | **Export Users**.



3. Select the user account that you want to export.
4. Select the right arrow  to export the user account.
5. Choose the destination to save the user account from the drop-down menu, or select the Save button  to browse to the USB device.
6.  Select the OK button to save changes and exit. The user account is exported.

Import Users

Import user accounts from one system to another, or from a backup USB device.



What you need:

- A USB device with user accounts already saved on it, or a folder on the Intellispec hard drive with valid user accounts
- Administrator access

To import a user account:

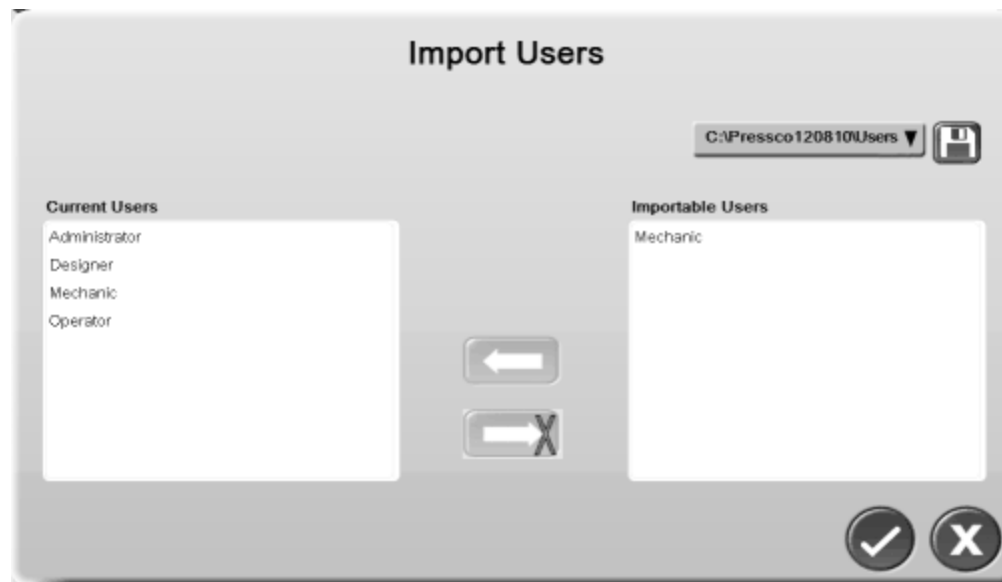
1. Insert the USB device into an available slot on the Intellispec Series V system.
2. Select the button with your user name **Bob** | **Import Users**.





3. Select the user account that you want to import from the right column. If you do not see any users available, select the Save button  to browse to a location where the user account is saved.
4. Select the left arrow  to import the user account.
5.  Select the OK button to save changes and exit. The user account is imported.

Set Up Auto Logout

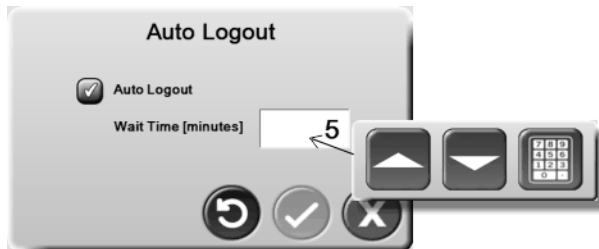
This feature will automatically log out any user after a number of minutes of inactivity.



To set up Auto Logout:

1. Log in.
2. Select the button with your user name .
3. Select **Setup Auto Logout**. The setup menu is displayed.
4. Enable **Auto Logout**. A check mark is displayed in the box when it is enabled.
5. Set the **Wait time in minutes** (from 1 to 9999 minutes).
6.  Select the OK button to save changes and exit. All users will be logged out automatically after the set number of minutes of inactivity.

This page left blank intentionally

System Tools

Log Reader

To get to this menu: select Home

 | Tools  | Log Reader.

The log reader displays the Intel-lispec event history including:

- User log in and log out information
- Notification when the part program was changed. Note: detailed changes to parameters and program changes are found in the [Part Program Change Log](#)
- Alarms, when triggered and cleared
- System errors
- System starting information
- Lane online/ offline history
- Lighting changes
- Reports generated
- Text files of the logs are stored at: C:\Pressco\Logs.

Log Reader

	Date	Time	Lane	Message	User	Online	Part Program	
Tue	2011-11-22	17:03:05	(2) Nickle	System went offline.	Administrator	Offline	Nickel	R
Tue	2011-11-29	09:27:47	(0) System	System process starts.	Administrator	Offline	default	
Tue	2011-11-29	09:28:18	(0) System	Internal Error	Administrator	Offline	default	
Tue	2011-11-29	09:28:31	(4) Quarter	Lane process starts.	Administrator	Offline	Measurement_test	
Tue	2011-11-29	09:28:31	(4) Quarter	Version: 5.0.467 (XP, 32 bit)	Administrator	Offline	Measurement_test	
Tue	2011-11-29	09:28:31	(4) Quarter	Built: 11/28/2011 3:29:07 PM	Administrator	Offline	Measurement_test	
Tue	2011-11-29	09:28:31	(4) Quarter	Built by: dpaunescu	Administrator	Offline	Measurement_test	
Tue	2011-11-29	09:28:31	(4) Quarter	Built on machine: DPOP755	Administrator	Offline	Measurement_test	
Tue	2011-11-29	09:28:31	(4) Quarter	Built on operating system: Microsoft Windows NT 5.1.2600 Service...	Administrator	Offline	Measurement_test	
Tue	2011-11-29	09:28:31	(4) Quarter	Build changed from '5.0.465 (XP, 32 bit)' to '5.0.467 (XP, 32 bit)'.	Administrator	Offline	Measurement_test	
Tue	2011-11-29	09:28:31	(2) Nickle	Lane process starts.	Administrator	Offline	Nickel	R
Tue	2011-11-29	09:30:20	(2) Nickle	Sensor 'Neck' with Id 2 in the part program 1L squat blue was not fo...	Administrator	Offline	Nickel	
Tue	2011-11-29	09:30:20	(2) Nickle	Sensor 'Seal' with Id 3 in the part program 1L squat blue was not fou...	Administrator	Offline	Nickel	
Tue	2011-11-29	09:30:20	(2) Nickle	Sensor 'Neck' with Id 2 in the part program .5L Snapple Clear was n...	Administrator	Offline	Nickel	
Tue	2011-11-29	09:30:20	(2) Nickle	Sensor 'Seal' with Id 3 in the part program .5L Snapple Clear was no...	Administrator	Offline	Nickel	
Tue	2011-11-29	09:30:22	(0) System	Was not able to connect to a UPS	Administrator	Offline	default	
Tue	2011-11-29	09:30:41	(0) System	User 'Administrator' has logged in.	Administrator	Offline	default	
Tue	2011-11-29	09:32:03	(2) Nickle	System went offline.	Administrator	Offline	Nickel	
Tue	2011-11-29	09:41:35	(1) Penny	System went online.	Administrator	Online	Penny	
Tue	2011-11-29	09:41:36	(1) Penny	System went offline.	Administrator	Offline	Penny	

Navigate

Reporting

The Intellispec generates many different reports to provide inspection detail. Many of these reports can be transferred outside of the Intellispec.

Note: Some menu items are only available to advanced level users.

To view reports: Select a Lane button **Lane n** | Tools  | **Reporting**.

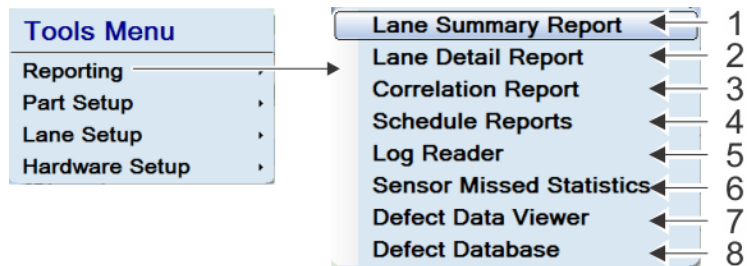

1 and 2 - "Lane Summary and Lane Detail reports" on the facing page

3 - "Correlation Report" on page 30

4 - "Schedule Reports" on page 31

5 - Log Reader

6 - **Sensor Missed Statistics** Displays the number of missed parts and missed part tracking for the sensor.

7 - **Defect Data Viewer** [if enabled] view the **images** in the defect database

8 - **Defect Database** [if enabled] view the **inspection data** from the defect database

Lane Summary and Lane Detail reports

Lane Summary Report

This report lists the statistics for the lane, including:

- Number of parts inspected
- Number of defects
- Defect percentage

The above numbers are reported per sensor, and as an overall number for the lane. An example from a one lane system is shown below.

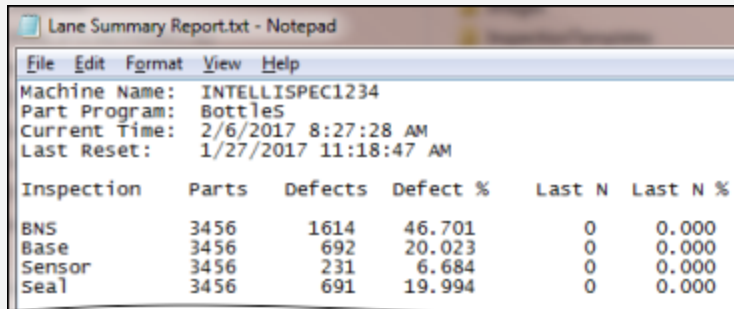

Inspection	Parts	Defects	Defect %	Last N	Last N %
BNS	3456	1614	46.701	0	0.000
Base	3456	692	20.023	0	0.000
Sensor	3456	231	6.684	0	0.000
Seal	3456	691	19.994	0	0.000

Lane Detail Report

This report contains all the information in the Lane Summary Report, plus inspection detail for each sensor.

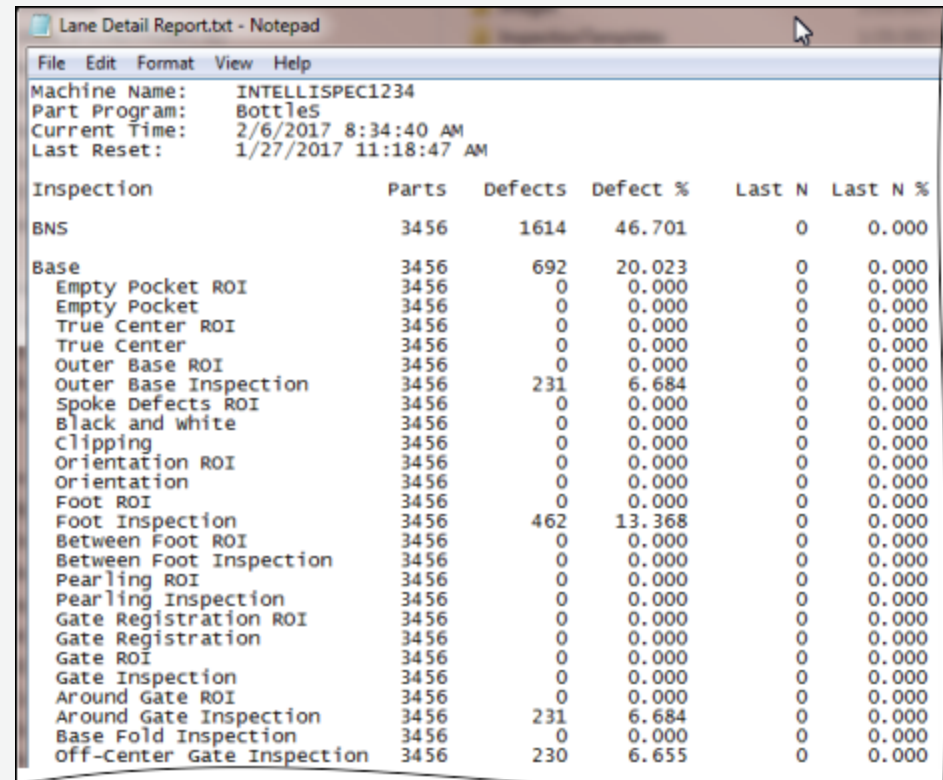

Inspection	Parts	Defects	Defect %	Last N	Last N %
BNS	3456	1614	46.701	0	0.000
Base	3456	692	20.023	0	0.000
Empty Pocket ROI	3456	0	0.000	0	0.000
Empty Pocket	3456	0	0.000	0	0.000
True Center ROI	3456	0	0.000	0	0.000
True Center	3456	0	0.000	0	0.000
Outer Base ROI	3456	0	0.000	0	0.000
Outer Base Inspection	3456	231	6.684	0	0.000
Spoke Defects ROI	3456	0	0.000	0	0.000
Black and white	3456	0	0.000	0	0.000
Clipping	3456	0	0.000	0	0.000
Orientation ROI	3456	0	0.000	0	0.000
Orientation	3456	0	0.000	0	0.000
Foot ROI	3456	0	0.000	0	0.000
Foot Inspection	3456	462	13.368	0	0.000
Between Foot ROI	3456	0	0.000	0	0.000
Between Foot Inspection	3456	0	0.000	0	0.000
Pearling ROI	3456	0	0.000	0	0.000
Pearling Inspection	3456	0	0.000	0	0.000
Gate Registration ROI	3456	0	0.000	0	0.000
Gate Registration	3456	0	0.000	0	0.000
Gate ROI	3456	0	0.000	0	0.000
Gate Inspection	3456	0	0.000	0	0.000
Around Gate ROI	3456	0	0.000	0	0.000
Around Gate Inspection	3456	231	6.684	0	0.000
Base Fold Inspection	3456	0	0.000	0	0.000
off-Center Gate Inspection	3456	230	6.655	0	0.000

Correlation Report

This report contains the percentage of defects by machine part, sorted from highest to lowest percentage of failure.

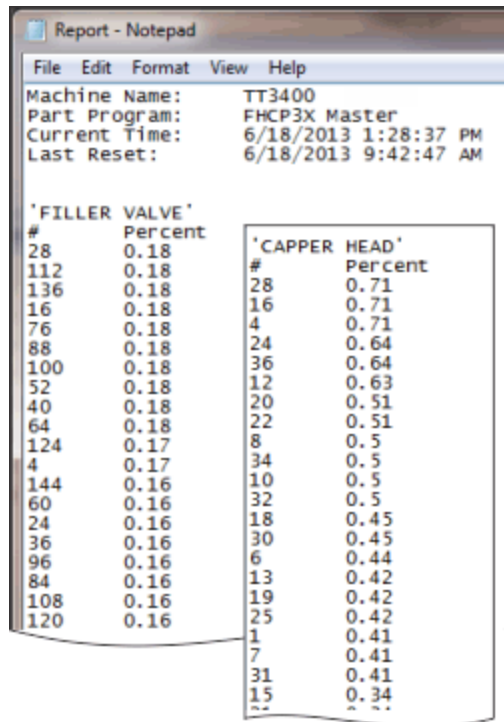

Report - Notepad

File Edit Format View Help

Machine Name: TT3400
Part Program: FHCP3X Master
Current Time: 6/18/2013 1:28:37 PM
Last Reset: 6/18/2013 9:42:47 AM

'FILLER VALVE'

#	Percent
28	0.18
112	0.18
136	0.18
16	0.18
76	0.18
88	0.18
100	0.18
52	0.18
40	0.18
64	0.18
124	0.17
4	0.17
144	0.16
60	0.16
24	0.16
36	0.16
96	0.16
84	0.16
108	0.16
120	0.16

'CAPPER HEAD'

#	Percent
28	0.71
16	0.71
4	0.71
24	0.64
36	0.64
12	0.63
20	0.51
22	0.51
8	0.5
34	0.5
10	0.5
32	0.5
18	0.45
30	0.45
6	0.44
13	0.42
19	0.42
25	0.42
1	0.41
7	0.41
31	0.41
15	0.34
~	~

Schedule Reports

Set up a schedule where the Intellispec generates reports automatically. This is a Lane-level setting. To schedule reports for more than one lane, you must repeat the process for each lane.

To schedule reports: From **Lane Overview** mode, select Tools  | **Reporting** | **Schedule Reports**.

- 1 - Report drop-down menu
- 2 - Enable Scheduled Report
- 3 - Destination drop-down menu
- 4 - Print on Change-Over
- 5 - Keep File Name
- 6 - Clear Statistics
- 7 - Next Scheduled Report
- 8 - Time Between Reports
- 9 - Preview

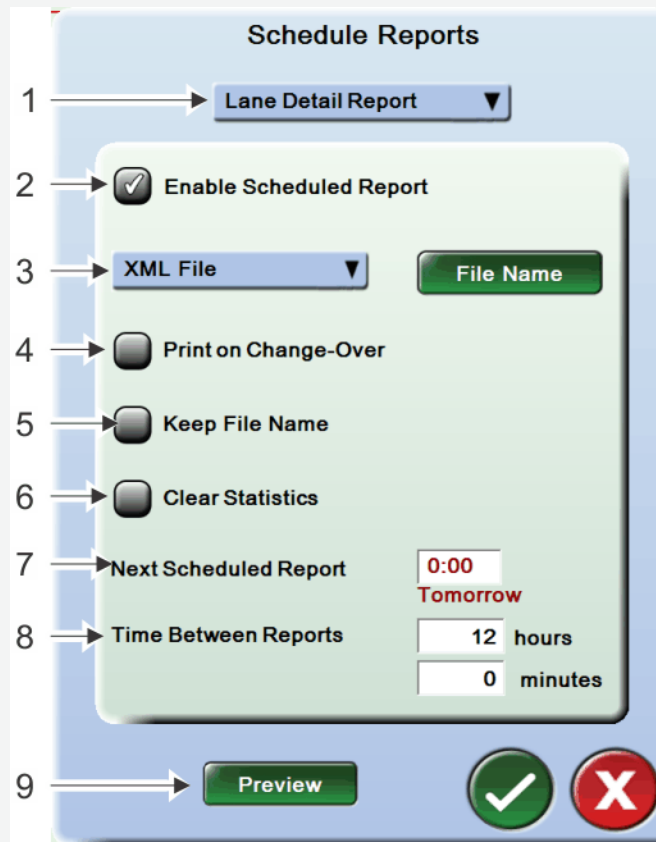

The screenshot shows the 'Schedule Reports' dialog box with the following controls and callouts:

- 1: Lane Detail Report (dropdown menu)
- 2: Enable Scheduled Report
- 3: XML File (dropdown menu) and File Name (button)
- 4: Print on Change-Over
- 5: Keep File Name
- 6: Clear Statistics
- 7: Next Scheduled Report (0:00 Tomorrow)
- 8: Time Between Reports (12 hours, 0 minutes)
- 9: Preview (button)

Schedule Reports Details

- 1 - **Report drop-down menu** Select a report to schedule. Each report must be set up separately. See also Lane Summary Report, Lane Detail Report, and Correlation Report.
- 2 - **Enable Scheduled Report** When this box is checked, the settings below are active.
- 3 - **Destination drop-down menu** Send the report to the default printer or a file. When "Text File" is selected, you can enter a file name by selecting the File Name button. If you do not choose the name or location of the file, then the file is named "Report.txt" and is saved at the hard disk location "c:\Pressco\DataExport." Subsequently saved reports include a time stamp in the file name, unless you enable **Keep File Name**.
- 4 - **Print on Changeover** Schedule the system to generate a report if someone changes a part program. This contains defect statistics from the time of the last statistics reset until the time that the part change-over occurred.

Changeover Report Example

This report contains defect information for the most recent parts. It has the time of the last statistics reset, and displays information through the time that the part change-over occurred.

Inspection	Parts	Defects	Defect %	Last N	Last N %
Lane 1	97703	14606	14.949	135	13.500
Main	97703	3908	4.000	36	3.600
Neckring Reg ROI	97703	0	0.000	0	0.000
Neckring Reg	97703	0	0.000	0	0.000
Color 1	97703	6772	6.931	63	6.300
Neckring Reg ROI	97703	0	0.000	0	0.000
Neckring Reg	97703	0	0.000	0	0.000
Color 2	97703	4652	4.761	42	4.200
Neckring Reg ROI	97703	0	0.000	0	0.000
Neckring Reg	97703	0	0.000	0	0.000

5 - **Keep File Name** The system overwrites the file each time, rather than creating unique names for files. Select the File Name button, browse to the location where you want to save it, and create a name for your report. **Example:** a plant where the Intellispec is networked. Say the office computer is programmed to poll the Intellispec at regular intervals to get the latest statistics report. With the same file name, the office computer just needs to request the same file name each time, regardless of the date and time the report was saved.

6 - **Clear Statistics** The Lane statistics are cleared after each report.

7 - **Next Scheduled Report** Using a 24 hour clock, set the time to save or print the next report. No reports will print until the specified time. This time of day is always used in subsequent report days, so that you can schedule your network computer to collect reports after this time. Note that this number is updated by the system continuously - it will always show the next scheduled report time. **Example:** if the current time is 17:00, and Next Scheduled Report is 15:00, then the next report will not print till the next day at 15:00.

8 - **Time Between Reports** Set the time interval to save or print the following reports. This interval is used after the Next Scheduled Report. The reports on following days are scheduled to always include the Next Scheduled Report time as originally set up.

Example: Time Between Reports

Next Scheduled Report = 15:00 and **Time Between Reports** = 5 hours. The reports will print the next day at 15:00, then at 20:00. The following day, the scheduled reports occur at 00:00, 05:00, 10:00, 15:00, and 20:00. This repeats each following day.

If the system is shut down when a report is scheduled and later started up again, then no report is created for the time when the system is shut down. This is true with the following exceptions:

- If a report was already created today, or the report schedule was edited today
- If the shut down was today
- If either of the above conditions happens, and a report was scheduled during the down time, then a report is created immediately after the system starts up again.

9 - **Preview** Select the preview button to see when scheduled reports will print.

Preview Details

Schedule Preview			
Details		Text File	C:\Pressco\Lane 1\Report*.br
Summary		XML File	C:\Pressco\Lane 1\Report.xml
Preview generated for 11/24/2014 11:22 AM.			
Time	Cleared?	Details	Summary
Today			
4:08 PM	✓	✓	←
Tomorrow			
4:08 AM	✓	✓	
10:08 AM			✓
4:08 PM	✓	✓	←
10:08 PM			✓

1 - Enabled reports | 2 - If ✓, that report will print today at the time shown | 3 - If ✓, that report will print tomorrow and each day after at the time shown

Cleared = Clear Statistics is enabled for that report.

Change-over Report Example

This report contains defect information for the most recent parts. It has the time of the last statistics reset, and displays information through the time that the part change-over occurred.

Line 5 Detail Report_2013-06-18_13-31-32.txt - Notepad

File Edit Format View Help

Machine Name: TT3400
 Part Program: FHCP3X Master
 Current Time: 6/18/2013 1:31:32 PM
 Last Reset: 6/18/2013 9:42:47 AM

Inspection	Parts	Defects	Defect %	Last N	Last N %
Lane 1	97703	14606	14.949	135	13.500
Main	97703	3908	4.000	36	3.600
Neckring Reg ROI	97703	0	0.000	0	0.000
Neckring Reg	97703	0	0.000	0	0.000
Color 1	97703	6772	6.931	63	6.300
Neckring Reg ROI	97703	0	0.000	0	0.000
Neckring Reg	97703	0	0.000	0	0.000
Color 2	97703	4652	4.761	42	4.200
Neckring Reg ROI	97703	0	0.000	0	0.000
Neckring Reg	97703	0	0.000	0	0.000

Alarms

There are five types of alarms: System, Lane, Sensor, Rejector, and Machine Part alarms. Most of these are configurable (except the System Alarms - UPS and over temperature).

The information in this section is valid in software versions 5.6.010, 5.7.008 and higher.

Note: Alarms are recorded in the system log reader, even when the alarms are automatically cleared.

View and Clear Alarms

ALARM

To View or Clear Alarms, select an Alarm button. If no alarm is active, click  | **View/Clear Alarms**.

Select the **Clear** button to clear a single alarm, or the **Clear All** button to clear all alarms, including alarms in other tabs.

Select different tabs to see more alarms. The tabs (except Lane) have sub-tabs. If any alarm is raised in a sub-tab (Sensor 1 in our example), then the container tab (Sensor) also shows an alarm.

Select any indicator to see alarm details. You can also do this if an alarm is not active.

The indicators in this screen show whether an alarm is enabled, and whether it is triggered.

 Red On - the alarm is both enabled and triggered

 Green On - the alarm is enabled, but has not been triggered

 Green Off - the alarm is not enabled nor triggered

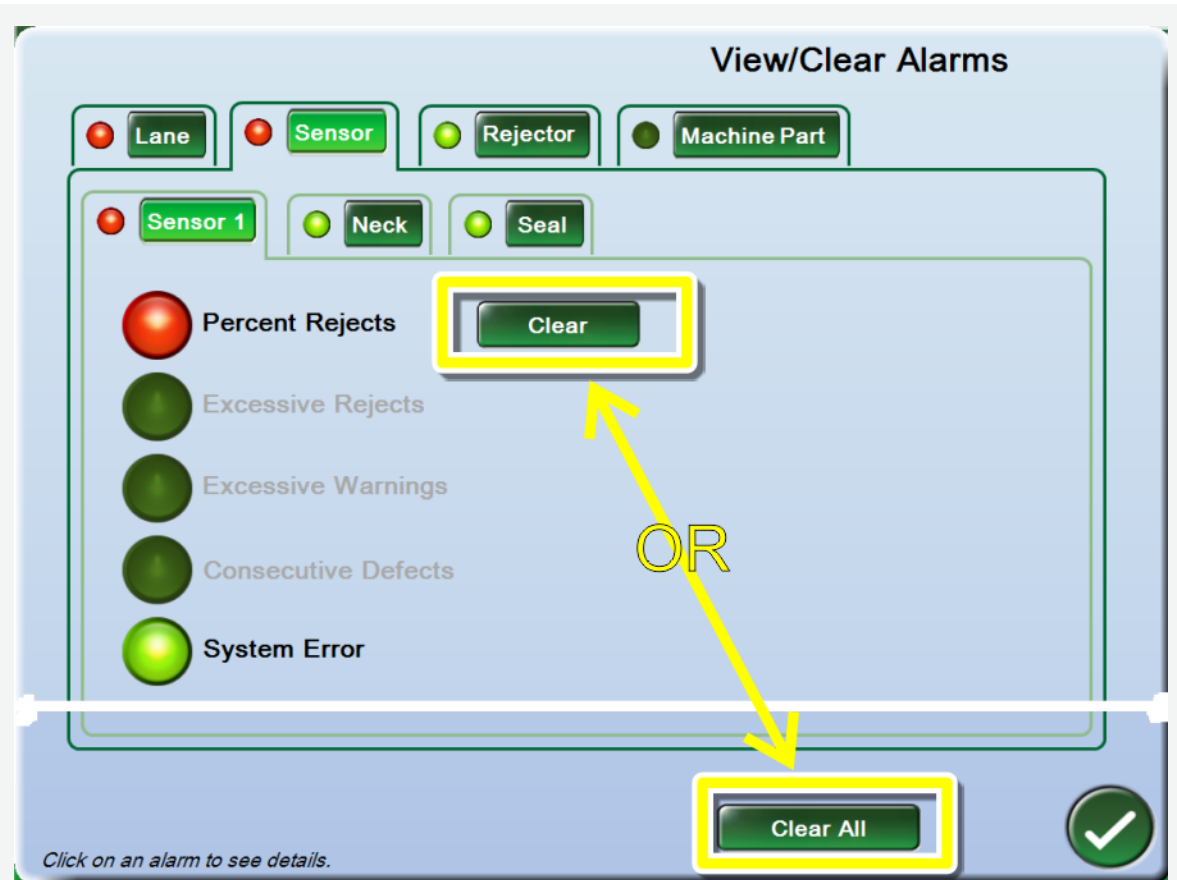

View and Clear Machine Part Alarms

From  | View/ Clear Alarms | Machine Part:

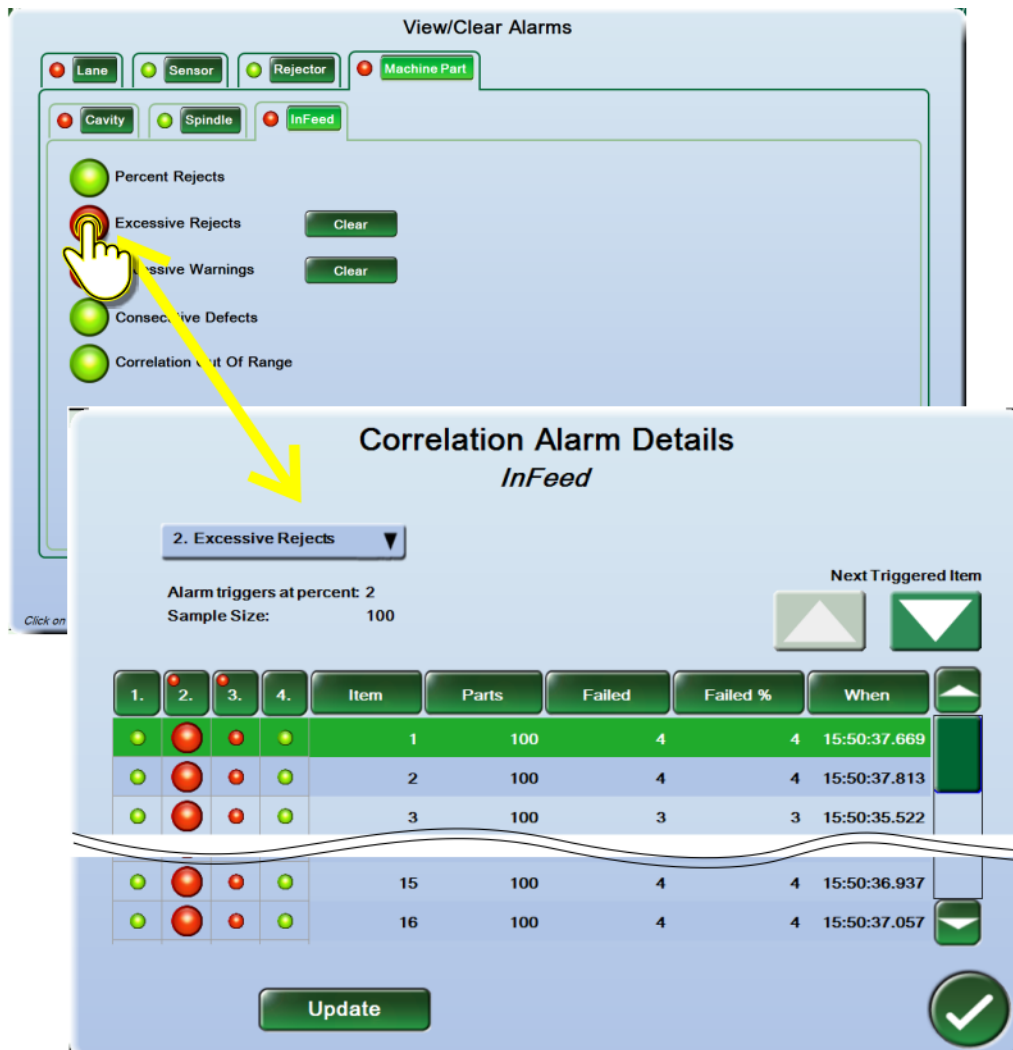

The screenshot shows the 'View/Clear Alarms' interface with several alarm categories: Lane, Sensor, Rejector, Machine Part, Cavity, Spindle, and InFeed. A hand cursor is clicking on the 'Excessive Rejects' alarm under the 'InFeed' category. A yellow arrow points from this alarm to the 'Correlation Alarm Details' dialog box.

The 'Correlation Alarm Details' dialog for 'InFeed' shows:

- Alarm triggers at percent: 2
- Sample Size: 100
- Next Triggered Item: (Up/Down arrows)
- Drop-down menu: 2. Excessive Rejects

1.	2.	3.	4.	Item	Parts	Failed	Failed %	When
				1	100	4	4	15:50:37.669
				2	100	4	4	15:50:37.813
				3	100	3	3	15:50:35.522
				15	100	4	4	15:50:36.937
				16	100	4	4	15:50:37.057

Buttons: Update, [Checkmark]

Clicking on any machine part alarm shows a details table breaking the alarm details down per correlation value (aka machine part item).

The table lets you select any of the (enabled) alarms either by using the drop down or by clicking one of the columns 1., 2., 3., etc.

A **Next Triggered Item** navigator helps to quickly find the item in alarm when all machine parts cannot be displayed simultaneously.

The **Update** button updates current inspection information (how many parts have currently been processed and how many failed; this is automatically done if an alarm is raised while in this view).

System Alarms - Description and Configuration

The system alarms are the UPS (uninterruptible power supply) and CPU temperature alarms. You can configure the UPS shut down time. These are only shown in the **System Overview** and will not show up as flashing lane buttons, or on any light tree, and will not sound a horn.

Alarm	Description	Action
UPS	Battery is dead. Or: Plant power is lost and the UPS shut-down time is exceeded. The Intellispec shuts down.	Replace battery Automatically resets If plant power is restored before the Intellispec shuts down, then the alarm is automatically cleared. Otherwise, restart the system.
Over temperature	CPU temperature exceeds highest recommended operating temperature. The Intellispec system shuts down. You must wait till the processor cools before resuming operation.	

System Alarm Setup

To get to this menu: select Home  | Alarms .

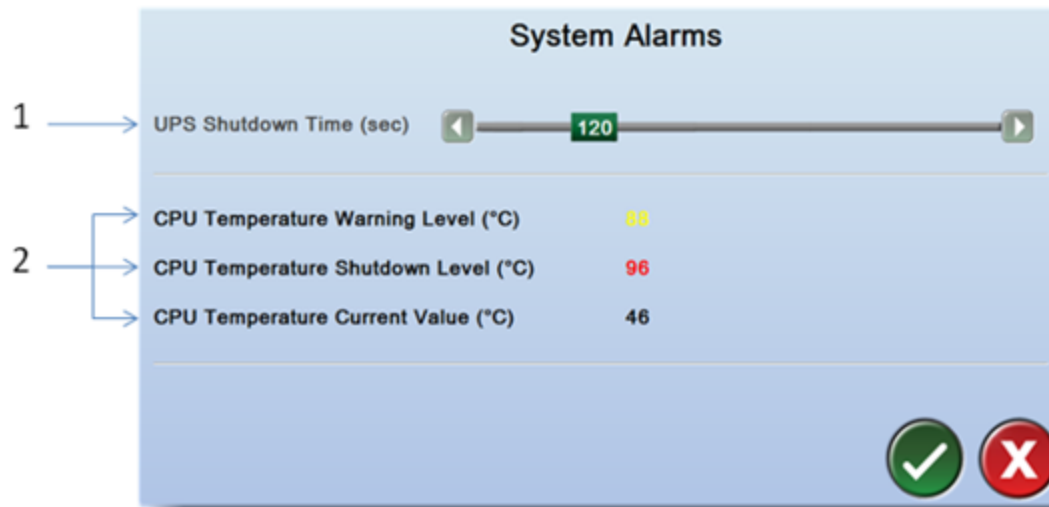









1 - **UPS Shutdown Time** The number of seconds that the UPS will maintain power to the system if AC power has been lost. The Intelispec system shuts down after this time period. This allows for a normal Windows shutdown.

2 - **CPU Temperature** If a multiple core computer is used, the highest temperature is displayed. If the shutdown CPU temperature is reached, the Intelispec system shuts down.

Lane Alarms - Brief Description

The Lane Alarms affect the hardware associated with one lane. A lane usually refers to one production line, and can contain multiple sensors.

Alarm	Description	Action	Light Tree ²
Percent Defects ¹	Percentage of defects exceeds the set limit.	Check the production line to see what might be creating too many bad parts Reset alarm on screen	 Red
Offline ¹	Lane goes offline	Automatically resets	 Green = system is online  Red = system is offline
Chute Full ¹	Reject chute is full	Clear chute Reset alarm on screen	 Red
Power Status ¹	Lane AC Power is lost	Automatically resets Troubleshoot: Check that the inspection module power switch is on. Check +24V supply.	 Red = AC power is lost  Blue = power is OK
Good Parts ¹	Used as a part counter. When specified number of parts is reached, then alarm is triggered.	Replace the box with counted parts with an empty box, then clear alarm. Reset alarm on screen	 Red
System Error ¹	Part tracker or other internal system errors	Depends on specific alarm (see details for System Error Alarm) Reset alarm on screen	 Red Red Flashing for Part Tracker Lost Communication

¹ If you want to connect an external monitoring device such as a PLC, an optional Extended I/O board is required for each lane.

² The light tree displays this color for the Duration if Visual Enabled.

Lane Alarm Configuration

Set up alarms for a lane.

Note: Some menu items are only available to advanced level users.

To get to this menu: From Lane Overview mode, select Alarms  | **Lane Alarm Configuration**. Select an alarm from the drop-down menu to configure that alarm. ✓ = enabled.

- 1) **Lane** Select the lane to configure
- 2) Selected alarm:

✓Percent Defects	A
Offline	B
Chute Full	C
Power Status	D
Good Parts	E
✓System Error	F

- A) **Percent Defect** The percentage of defective parts in a Lane exceeds the **Trigger %**. It remains triggered until you clear the alarm.
- B) **Offline alarm** This alarm is triggered when the system goes offline.
- C) **Chute Full alarm** This alarm is mainly used in systems that have inspection modules installed within a blow molder, and use the blow molder's internal reject chute. (it may not apply to your system) It is triggered when the blow molder's internal reject chute is full. NOTE: This alarm is disabled when the Intellispec is offline.
If this alarm is triggered, the blow molder's internal rejector will be disabled, thus not allowing any more defective parts to be rejected. The rejector will remain disabled until you clear the chute and then clear the alarm from the alarms tab. If you clear the alarm without clearing the chute, the alarm will be triggered again.
- D) **Power Status** This alarm is triggered when Lane AC power is lost. It remains triggered until AC power is restored. If AC power remains off for an extended period of time, the system will shut down.
- E) **Good Parts alarm** This alarm is triggered when a number of good inspected parts [Trigger (thousands)] has been reached. It will remain triggered until you clear the alarm. Note that clearing this alarm also clears the Good Parts count.

Good Parts alarm example

The Good Parts alarm can be used as a part counter. For example, say you are inspecting preforms, and have a box at the end of the conveyor (after inspection) that holds 5000 preforms. This alarm counts the number of good inspected parts, and notifies you when 5000 good parts have reached that box. The Alarm Output through the optional Extended I/O can be used to stop the conveyor from moving parts into the inspection system. You can then install a new box at the end of the conveyor, reset this alarm, and start counting the next 5000 parts. See also information about the optional Extended I/O board.

- F) **System Error Alarm** The System Error Alarm cannot be disabled. However, there is a **Details** button that shows whether it is being used as an alarm. System alarms may be added or subtracted (by Pressco) from the software without notice. These errors are recorded in the Log Reader.

System Error alarm details

	Use as Alarm	Count Only
Part Tracker Lost Communication	<input type="radio"/>	<input type="radio"/>
Part Tracker Closed Connection	<input type="radio"/>	<input type="radio"/>
UDP zero-length message	<input type="radio"/>	<input type="radio"/>
Internal Error	<input type="radio"/>	<input type="radio"/>
Extended I/O Alarm	<input type="radio"/>	<input type="radio"/>

- **Part Tracker Lost Communication** – a transient problem with sending result packets to the part tracker. Often this is related to a Missed Packets threshold that is too low (Missed Packets Exception under Lane – Tools – Hardware Setup). Otherwise, network connections may need to be checked. The light tree will flash red.
- **Part Tracker Closed Connection** – The communication to the part tracker was closed. This always requires resetting the part tracker and restarting the system. The system will also show a message box instructing to do this, and going on-line will not be permitted. In this condition, since no communication between Intellispec and Part Tracker exists, the light tree may not show an alarm or sound the horn.
- **Internal Error** - an internal error was logged. This usually requires Pressco technical assistance.
- **Use as Alarm** - This is the normal setting.
- **Count Only** - The selected alarm(s) will count triggers only.
 - In the View/Clear Alarms screen, the indicator will be yellow if the alarm is triggered (instead of red).
 - The Count Only alarms will NOT light the light tree, sound the horn, nor cause the flashing ALARM button over the Lane button.
 - A small warning indicator displays over the Alarms button and View/Clear Alarms menu item when one or more count-only alarms have been triggered - in Lane Overview mode only. The warning indicator is not displayed when a regular alarm is already active.



We do not recommend using Count Only for any of the System alarms, unless the system has a problem where a specific alarm is frequently triggered and thus overshadows other alarms.

- 3) **Alarm Enabled** Enables the alarm.
- 4) **Minimum Count** The minimum number of parts that must be inspected before the alarm can be triggered. This prevents the alarm from being triggered too soon, when only a small number of parts may make the statistics trigger the alarm.
- 5) **Trigger [%]** The percentage of parts inspected that must fail, to trigger the Percent Defects alarm. This number is selectable between zero and 100. The default value is five percent.
- (not shown) **Trigger [parts]** [Good Parts alarm] The number of parts (in thousands) that must pass inspection to trigger the alarm.
- 6) **Audible Enabled** The horn will sound when the alarm is triggered.
- 6A) **Audible Duration** The number of seconds the horn will sound. After this time it will remain on off until the alarm is cleared.
- 7) **Visual Enabled** The appropriate light tree segment will light when the alarm is triggered.
- 7A) **Visual Duration** The number of seconds the light tree will remain on when the alarm is triggered. After this time it will remain on off until the alarm is cleared.
- 8) **Alarm Digital Outputs** Select an output (Inspection Alarm 0-14) to be toggled on the optional Extended I/O kit when the alarm is triggered.

Alarm Digital Outputs details

- There are 15 available Inspection Alarm outputs that correspond to the extended I/O signals. Select one of the output numbers to assign the current alarm to an output.
- These outputs go active when the alarm is triggered, and go inactive when the alarm is cleared, provided no other alarm is still active that uses the same output.
- The outputs can be monitored by your plant equipment, such as a PLC, to notify you when certain alarms are triggered.
- See the Intellispec Hardware Guide for information about Extended I/O.

9) **All Alarms** Select the All Alarms button from an alarm configuration window (Lane, Sensor, Rejector, or Machine Part). See also "All Alarms" on page 63

10) **Apply Alarm to** Click on additional lanes (if applicable to your system) to simultaneously configure all lanes currently checked in the side list. Any changes to the currently visible settings are reflected in all checked lanes. When you uncheck a lane, the settings remain applied but the unchecked lane will not follow the visible changes anymore. Each alarm has a separate list of simultaneous lanes.

Apply Alarm to - details







"✓" means the settings are applied to those selections

"*" (asterisk) means the setting for the source differs from the current configuration

"≠" means the settings for the source and alarm differ from the currently visible settings

Sensor Alarms - Brief Description

Sensor alarms are configured for each sensor (camera or other sensor).

Alarm	Description	Action	Light Tree ²
Percent Rejects ¹	Percent Rejects This alarm is triggered when the Trigger [%] is exceeded. It will remain triggered until you clear the alarm.	Check the production line to see what might be creating too many bad parts Reset alarm on screen	 Red
Excessive Rejects ¹	Excessive Rejects This alarm is triggered when Trigger [%] of the last Sample Size parts have been found defective. It will remain triggered until you clear the alarm.	Check the production line to see what might be creating too many bad parts Reset alarm on screen	 Red
Excessive Warnings ¹	Excessive Warnings This alarm is triggered when Trigger [%] of the last Sample Size parts have been found with a warning status. It will remain triggered until you clear the alarm. Warnings are enabled in the Retro-Spec Options when you are editing an inspection. They can also be enabled in Lane Setup Select Features.	Check the production line to see what might be creating too many bad parts Reset alarm on screen	 Amber
Consecutive Defects ¹	Consecutive Defects This alarm is triggered when Consecutive Triggers has been exceeded [the sensor had too many consecutive defects]. It will remain triggered until you clear the alarm.	Check the production line to see what might be creating too many bad parts Reset alarm on screen	 Red
Mass Lighting	Mass Lighting - This alarm is triggered when the lighting threshold falls below a minimum level.	Clean the mass sensors and emitters Reset alarm on screen	none
System Error ¹	Missed part, missed acquisition, missed result, or other internal error	Reset alarm on screen	 Red

¹ If you want to connect an external monitoring device such as a PLC, an optional Extended I/O board is required for each lane.

² The light tree displays this color for the Duration if Visual Enabled.

Sensor Alarm Configuration

Set up alarms for a Sensor.

Some menu items are only available to advanced level users.

To get to this menu: From Lane or Sensor Overview mode, select Alarms  | Sensor Alarm Configuration. Choose a sensor to configure. You must configure each sensor separately. Select an alarm from the drop-down menu to configure that alarm. ✓ = enabled.

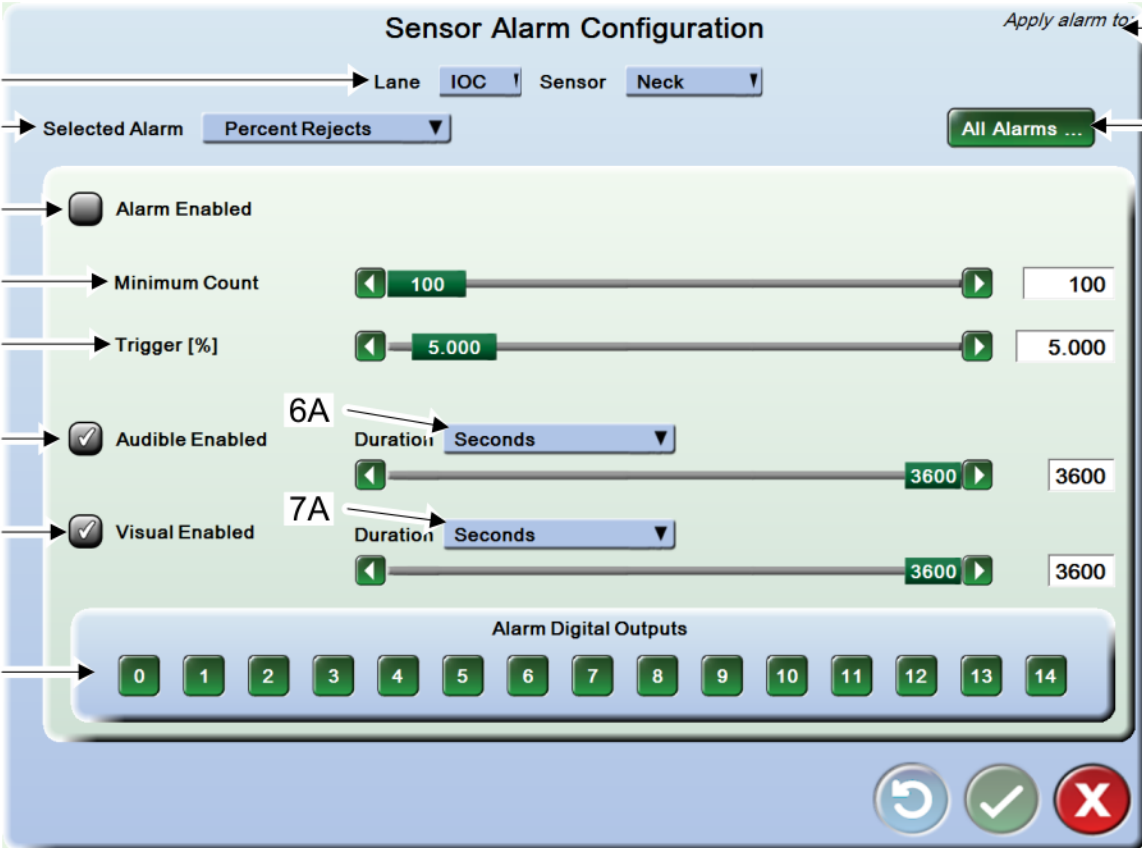

The screenshot shows the 'Sensor Alarm Configuration' interface. At the top, there are dropdown menus for 'Lane' (set to 'IOC') and 'Sensor' (set to 'Neck'). Below these is a 'Selected Alarm' dropdown set to 'Percent Rejects' and an 'All Alarms ...' button. The main configuration area includes several settings: 'Alarm Enabled' (checkbox), 'Minimum Count' (slider set to 100), 'Trigger [%]' (slider set to 5.000), 'Audible Enabled' (checkbox), 'Visual Enabled' (checkbox), and two 'Duration' settings (each set to 3600 seconds). At the bottom, there is an 'Alarm Digital Outputs' section with buttons numbered 0 through 14. The interface also features a 'Apply alarm to' label and a '9' callout pointing to the 'All Alarms ...' button.

- 1) Select a lane and sensor to configure.
- 2) Select an alarm to configure:

Percent Rejects	A
Excessive Rejects	B
Excessive Warnings	C
Consecutive Defects	D
✓ Mass Lighting	E
✓ System Error	F

- A) **Percent Rejects** This alarm is triggered when the **Trigger [%]** is exceeded. It will remain triggered until you clear the alarm.
- B) **Excessive Rejects** This alarm is triggered when **Trigger [%]** of the last **Sample Size** parts have been found defective. It will remain triggered until you clear the alarm.
- C) **Excessive Warnings** This alarm is triggered when **Trigger [%]** of the last **Sample Size** parts have been found with a warning status. It will remain triggered until you clear the alarm. Warnings are enabled in the **Retro-Spec Options** when you are editing an inspection. They can also be enabled in Lane Setup | Select Features.
- D) **Consecutive Defects** This alarm is triggered when **Consecutive Triggers** has been exceeded [the sensor had too many consecutive defects]. It will remain triggered until you clear the alarm.
- E) (only on systems with Mass sensors) **Mass Lighting** This alarm is triggered when, for the given sensor, the backlight measured for the part is below the Alarm Level given in the Mass Lighting dialog.
- F) **System Error Alarm** The System Error Alarm cannot be disabled. However, there is a Details button that shows whether it is being used as an alarm. System alarms may be added or subtracted (by Pressco) from the software without notice.

System Error alarm details

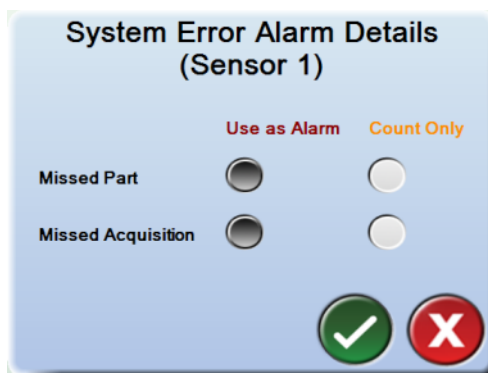

These errors are recorded in the Log Reader.

- **Missed Part** - the inspection was still being processed when the part made it to the reject station
- **Missed Acquisition** - the system was unable to acquire an image in time. There may be a problem with the camera or with the connection of the camera to the computer.
- **Use as Alarm** - This is the normal setting.
- **Count Only** - The selected alarm(s) will count triggers only.
 - The selected alarm(s) will be used as a warning. In the View/Clear Alarms screen, the indicator will be yellow if the alarm is triggered (instead of red).
 - The Count Only alarms will NOT light the light tree, sound the horn, nor cause the flashing ALARM button over the Lane button.
 - A small warning indicator displays over the Alarms button and View/Clear Alarms menu item when one or more count-only alarms have been triggered - in Lane Overview mode only. The warning indicator is not displayed when a regular alarm is already active.



We do not recommend using Count Only for any of the System alarms, unless the system has a problem where a specific alarm is frequently triggered and thus overshadows other alarms.

3) **Alarm Enabled** Enables the alarm.

4) **Minimum Count** The minimum number of parts that must be inspected before the alarm can be triggered. This prevents the alarm from being triggered too soon, when only a small number of parts may make the statistics trigger the alarm.

(not shown) **Sample Size** [Excessive Rejects and Excessive Warnings alarms] The number of parts that must be inspected, to determine the excessive warning percentage. This number is selectable between one and 100,000. The default value is 100. This is a sliding window: for example, assume Sample Size = 1,000 and Percent Trigger = 3. If three percent of the last 1000 parts have had a warning status, the alarm is triggered.

5) **Trigger [%]** The percentage of parts inspected that must fail, to trigger the Percent Defects alarm. This number is selectable between zero and 100. The default value is five percent.

(not shown) **Consecutive Triggers** [Consecutive Defects alarm] The number of defects in a row that must occur to trigger the alarm. This number is selectable between two and 100. The default value is 25.

6) **Audible Enabled** The horn will sound when the alarm is triggered.

6A) **Audible Duration** The number of seconds the horn will sound. After this time it will remain on off until the alarm is cleared.

7) **Visual Enabled** The appropriate light tree segment will light when the alarm is triggered.

7A) **Visual Duration** The number of seconds the light tree will remain on when the alarm is triggered. After this time it will remain on off until the alarm is cleared.

8) Alarm Digital Outputs

Alarm Digital Outputs details

- There are 15 available Inspection Alarm outputs that correspond to the extended I/O signals. Select one of the output numbers to assign the current alarm to an output.
- These outputs go active when the alarm is triggered, and go inactive when the alarm is cleared, provided no other alarm is still active that uses the same output.
- The outputs can be monitored by your plant equipment, such as a PLC, to notify you when certain alarms are triggered.
- See the Intellispec Hardware Guide for information about Extended I/O.

9) **All Alarms** Select the All Alarms button from an alarm configuration window (Lane, Sensor, Rejector, or Machine Part). See also "All Alarms" on page 63

10) **Apply Alarm to** Click on additional sensors to simultaneously configure all sensors currently checked in the side list. Any changes to the currently visible settings are reflected in all checked sensors. When you uncheck a sensor, the settings remain applied but the unchecked sensor will not follow the visible changes anymore. Each alarm has a separate list of simultaneous sensors.

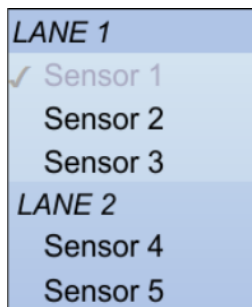

Apply Alarm to - details



- "✓" means the settings are applied to those selections
 - "*" (asterisk) means the setting for the source differs from the current configuration
 - "≠" means the settings for the source and alarm differ from the currently visible settings
-

Rejector Alarms - Brief Description

Rejector Alarms are triggered when a part did not get rejected as expected.

Alarm	Description	Action	Light Tree ²
Jam at Reject Confirm ¹	The reject confirm path has been blocked too long. Works with Reject Confirm Calibration (Optional)	Remove jammed parts at the rejecter, then clear alarm. Reset alarm on screen	 Red
Missed Reject ¹	System missed rejecting a part. Works with Reject Confirm Calibration (Optional)	Reset alarm on screen	 Red
Missed Result ¹	The part reached the rejector before the part was fully inspected and the result was sent to the part tracker. That is, the inspections took too long to run.	If this occurs often, look at the inspection settings. It may be possible to use other settings to reduce inspection time. Reset alarm on screen	 Red

¹ If you want to connect an external monitoring device such as a PLC, an optional Extended I/O board is required for each lane.

² The light tree displays this color for the Duration if Visual Enabled.

Rejector Alarms Configuration

Set up alarms for rejecting. To get to this menu: From Lane Overview mode, select Alarms  | **Rejector Alarm Configuration**. Select an alarm from the drop-down menu to configure that alarm. ✓ = enabled.

Note: Some menu items are only available to advanced level users.

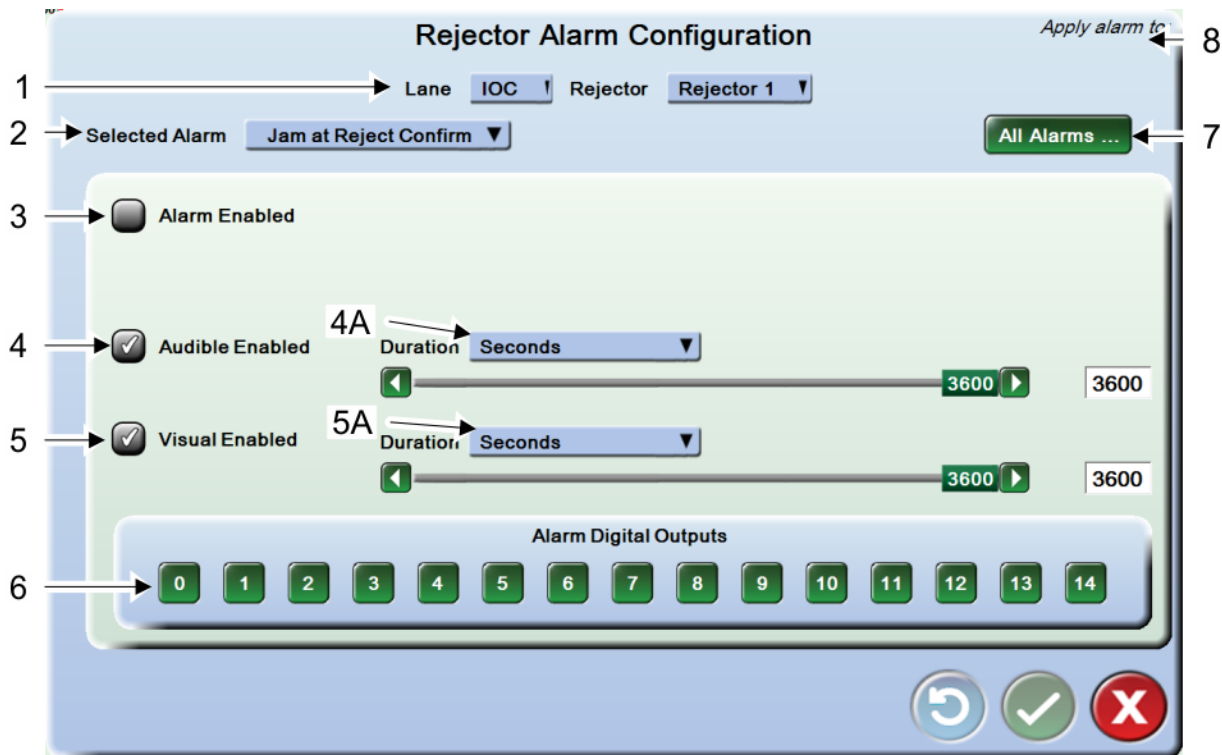

- 1) Select a lane and rejector to apply the current alarm to
- 2) Selected alarm:

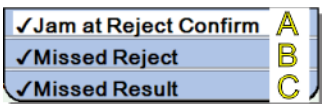

A) **Jam at Reject Confirm** This alarm is used with Reject Confirm Calibration (Optional). The alarm is triggered when the reject path has been blocked too long.

B) **Missed Reject** This alarm works in conjunction with Reject Confirm Calibration (Optional). It is triggered when a missed reject occurs. There will be two Missed Reject alarms available if two rejectors are enabled and two Reject Confirm rejectors are enabled.

C) **Missed Result** This signal is triggered if a part reaches the rejector without the part tracker having received the reject/not-reject command, determined by the inspection results. That is, the inspections took too long to run.

3) **Alarm Enabled** Enables the alarm.

4) **Audible Enabled** The horn will sound when the alarm is triggered.

4A) **Audible Duration** The number of seconds the horn will sound. After this time it will remain on off until the alarm is cleared.

5) **Visual Enabled** The appropriate light tree segment will light when the alarm is triggered.

5A) **Visual Duration** The number of seconds the light tree will remain on when the alarm is triggered. After this time it will remain on off until the alarm is cleared.

6) **Alarm Digital Outputs** Select an output (Inspection Alarm 0-14) to be toggled on the optional Extended I/O kit when the alarm is triggered.

Alarm Digital Outputs details

- There are 15 available Inspection Alarm outputs that correspond to the extended I/O signals. Select one of the output numbers to assign the current alarm to an output.
- These outputs go active when the alarm is triggered, and go inactive when the alarm is cleared, provided no other alarm is still active that uses the same output.
- The outputs can be monitored by your plant equipment, such as a PLC, to notify you when certain alarms are triggered.
- See the Intellispec Hardware Guide for information about Extended I/O.

7) All Alarms

8) Apply Alarm to: details

Click on additional rejectors (if applicable to your system) to simultaneously configure all rejectors currently checked in the side list. Any changes to the currently visible settings are reflected in all checked items. When you uncheck a rejector, the settings remain applied but the unchecked rejector will not follow the visible changes anymore. Each alarm has a separate list of

simultaneous rejectors.

"✓" means the settings are applied to those selections

"*" (asterisk) means the setting for the source differs from the current configuration

"≠" means the settings for the source and alarm differ from the currently visible settings



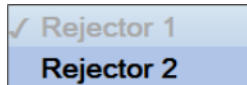

The options available are based on your system configuration, and may be different than shown here.



Machine Part Alarms - Brief Description

Machine Part alarms are the correlation-based alarms. They are visible only if your system has correlation sensors installed.

Note: for Machine Part Alarms, except Correlation Out of Range, statistics apply to each correlation value separately. That is, if one of 100 machine parts fails at 100 percent, the detected percentage is 100 percent while overall it would be 1 percent.

Alarm	Description	Action	Light Tree ²
Percent Rejects ¹	Percent Rejects This alarm is triggered when the Trigger [%] is exceeded. It will remain triggered until you clear the alarm.	Check the production line to see what might be creating too many bad parts Reset alarm on screen	 Red
Excessive Rejects ¹	Excessive Rejects This alarm is triggered when Trigger [%] of the last Sample Size parts have been found defective. It will remain triggered until you clear the alarm.	Check the production line to see what might be creating too many bad parts Reset alarm on screen	 Red
Excessive Warnings ¹	Excessive Warnings This alarm is triggered when Trigger [%] of the last Sample Size parts have been found with a warning status. It will remain triggered until you clear the alarm. Warnings are enabled in the Retro-Spec Options when you are editing an inspection. They can also be enabled in Lane Setup Select Features.	Check the production line to see what might be creating too many bad parts Reset alarm on screen	 Amber
Consecutive Defects ¹	Consecutive Defects This	Check the production line to see what might be creating too many	 Red

Alarm	Description	Action	Light Tree ²
	alarm is triggered when Consecutive Triggers has been exceeded [the sensor had too many consecutive defects]. It will remain triggered until you clear the alarm.	bad parts Reset alarm on screen	
Correlation Out of Range	Correlation Out of Range - This alarm is triggered if the part tracker counts a machine part that was not configured.	Reset alarm on screen	 Red

¹ If you want to connect an external monitoring device such as a PLC, an optional Extended I/O board is required for each lane.

² The light tree displays this color for the Duration if Visual Enabled.

Machine Part Alarms Configuration

Set up alarms for machine parts. To get to this menu: From Lane Overview mode, select Alarms  | **Machine Part Alarm Configuration**. Select an alarm from the drop-down menu to configure that alarm. ✓ = enabled.

Note: Some menu items are only available to advanced level users.

- 1) **Machine Part** Select the machine part to apply an alarm to
- 2) Selected Alarm:

Percent Rejects	A
Excessive Rejects	B
Excessive Warnings	C
Consecutive Defects	D
Correlation Out Of Range	E

- A) **Percent Rejects** This alarm is triggered when the **Trigger [%]** is exceeded. It will remain triggered until you clear the alarm.
- B) **Excessive Rejects** This alarm is triggered when **Trigger [%]** of the last **Sample Size** parts have been found defective for a correlation value. It will remain triggered until you clear the alarm.
- C) **Excessive Warnings** This alarm is triggered when **Trigger [%]** of the last **Sample Size** parts for a correlation value have been found with a warning status. It will remain triggered until you clear the alarm. Warnings are enabled in the **Retro-Spec Options** when you are editing an inspection. They can also be enabled in **Lane Setup | Select Features**.
- D) **Consecutive Defects** This alarm is triggered when Consecutive Triggers has been exceeded [the correlation value had too many consecutive defects]. It will remain triggered until you clear the alarm.
- E) **Correlation Out of Range** This alarm is triggered if the part tracker counts a machine part that was not configured. For example, if you configure 24 cavities, normally the part tracker counts 22, 23, 24, 1, 2, etc. If the part tracker sees 24, 25, 1, 2 then 25 is out of range. In **Machine Part Correlation**, you set a number of machine part items (Number) for each machine part. The part tracker continuously increases a counter for each machine part until it sees an index pulse, which resets the counter. When the counter runs longer than the “Number” configured, the correlation is out of range – the part tracker reports a machine part that does not exist (assuming the original configuration matches the physical number of machine parts).
- 3) **Alarm Enabled** Enables the alarm.
- 4) **Minimum Count** The minimum number of parts that must be inspected before the alarm can be triggered. This prevents the alarm from being triggered too soon, when only a small number of parts may make the statistics trigger the alarm.
- 5) **Trigger [%]** For a correlation value, the percentage of parts inspected that must fail, to trigger the Percent Defects alarm. This number is selectable between zero and 100. The default value is five percent.
- 6) **Audible Enabled** The horn will sound when the alarm is triggered.
- 6A) **Audible Duration** The number of seconds the horn will sound. After this time it will remain on off until the alarm is cleared.
- 7) **Visual Enabled** The appropriate light tree segment will light when the alarm is triggered.

7A) **Visual Duration** The number of seconds the light tree will remain on when the alarm is triggered. After this time it will remain on off until the alarm is cleared.

8) **Alarm Digital Outputs** Select an output (Inspection Alarm 0-14) to be toggled on the optional Extended I/O kit when the alarm is triggered.

Alarm Digital Outputs details

- There are 15 available Inspection Alarm outputs that correspond to the extended I/O signals. Select one of the output numbers to assign the current alarm to an output.
- These outputs go active when the alarm is triggered, and go inactive when the alarm is cleared, provided no other alarm is still active that uses the same output.
- The outputs can be monitored by your plant equipment, such as a PLC, to notify you when certain alarms are triggered.
- See the Intellispec Hardware Guide for information about Extended I/O.

9) All Alarms

10) **Apply Alarm to** Click on additional machine parts (if applicable to your system) to simultaneously configure all machine parts currently checked in the side list. Any changes to the currently visible settings are reflected in all checked items. When you uncheck a machine part, the settings remain applied but the unchecked machine part will not follow the visible changes anymore. Each alarm has a separate list of simultaneous machine parts.

10) Apply Alarm to - details

"✓" means the settings are applied to those selections

"*" (asterisk) means the setting for the source differs from the current configuration

"≠" means the settings for the source and alarm differ from the currently visible settings

The options available are based on your system configuration, and may be different than shown here.

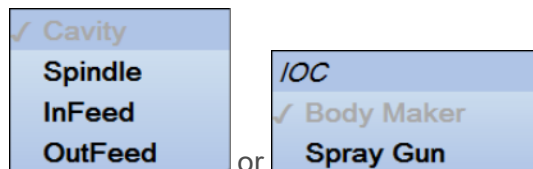

All Alarms

 **All Alarms** button from an alarm configuration window

Settings made here allow applying the same settings to all alarms on one or all lanes and one or all sources (depending on where from invoked: one or all Sensors, one or all Rejectors, one or all Machine Parts). For example, you may always want to use the same Visual Duration regardless of which alarm. This allows doing this in a single step without having to go through all alarms to apply the same setting. (You still have to do it separate for each source type: Lane, Sensor, Rejector, Machine Part.)

Example 1

In the example below, everything is enabled. When we apply the changes, all of the lane alarms will be enabled, and all the values shown in the right column will be applied.

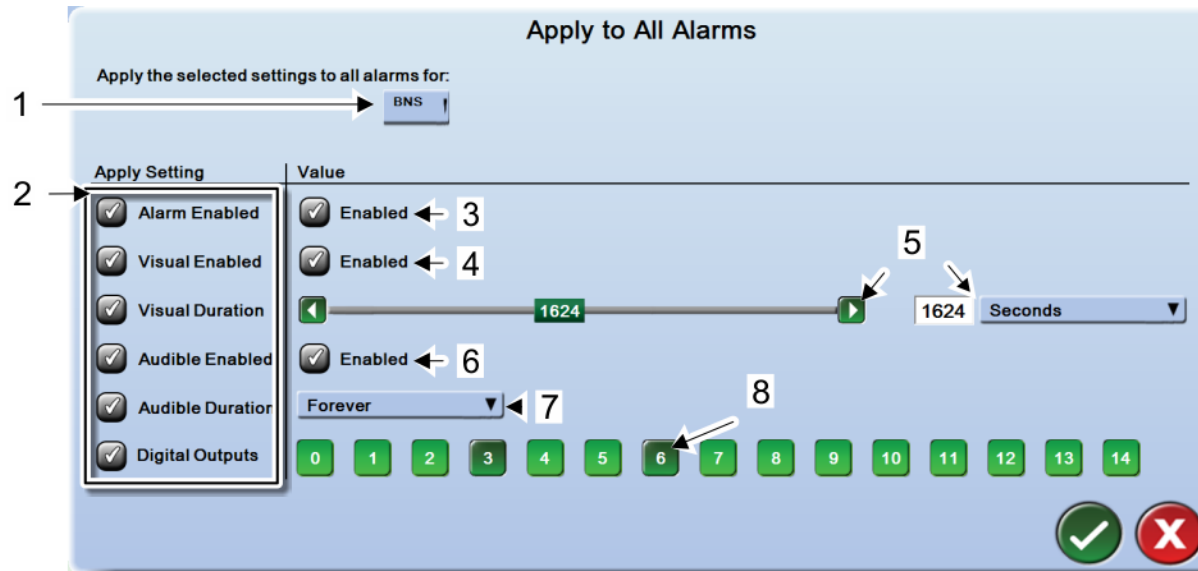

1) Select the item(s) for which the alarms settings will be applied (Lane, Sensor, Rejector, or Machine Part). More than one drop-down menu may be shown, depending on your configuration.

✓ = enabled

2) **Apply Setting** select which settings you want to apply to all alarms for the alarm sources selected in 1). If a box in Apply Setting is unchecked, the setting is NOT applied to any alarm and remains unchanged on OK.

Value column contains the value of the setting to apply.

- 3) **Alarm Enabled** Value “Enabled” checked (unchecked) = enables (disables) all alarms for the selected alarm sources.
- 4) **Visual Enabled** Value “Enabled” checked (unchecked) = The appropriate light tree segment will light (not light) for any alarm for the selected alarm sources when triggered.
- 5) **Visual Duration** Value = The number of seconds the light tree will remain on when the alarm is triggered. After this time it will remain on off until the alarm is cleared.
- 6) **Audible Enabled** Value “Enabled” checked (unchecked) = The horn will sound (not sound) for any alarm for the selected alarm sources when triggered.
- 7) **Audible Duration** Value = The number of seconds the horn will sound. After this time it will remain on off until the alarm is cleared.
- 8) Alarm Digital Outputs

Alarm Digital Outputs details

- There are 15 available Inspection Alarm outputs that correspond to the extended I/O signals. Select one of the output numbers to assign the current alarm to an output.
- These outputs go active when the alarm is triggered, and go inactive when the alarm is cleared, provided no other alarm is still active that uses the same output.
- The outputs can be monitored by your plant equipment, such as a PLC, to notify you when certain alarms are triggered.
- See the Intellispec Hardware Guide for information about Extended I/O.

Example 2

If we only check Alarm Enabled in the Apply Setting column, then only the state of the Enabled checkbox in the Value column would be applied. In this example, after clicking the OK button, all alarms would be disabled for all lanes (except for the SIM sensor) but no other alarm settings would change.

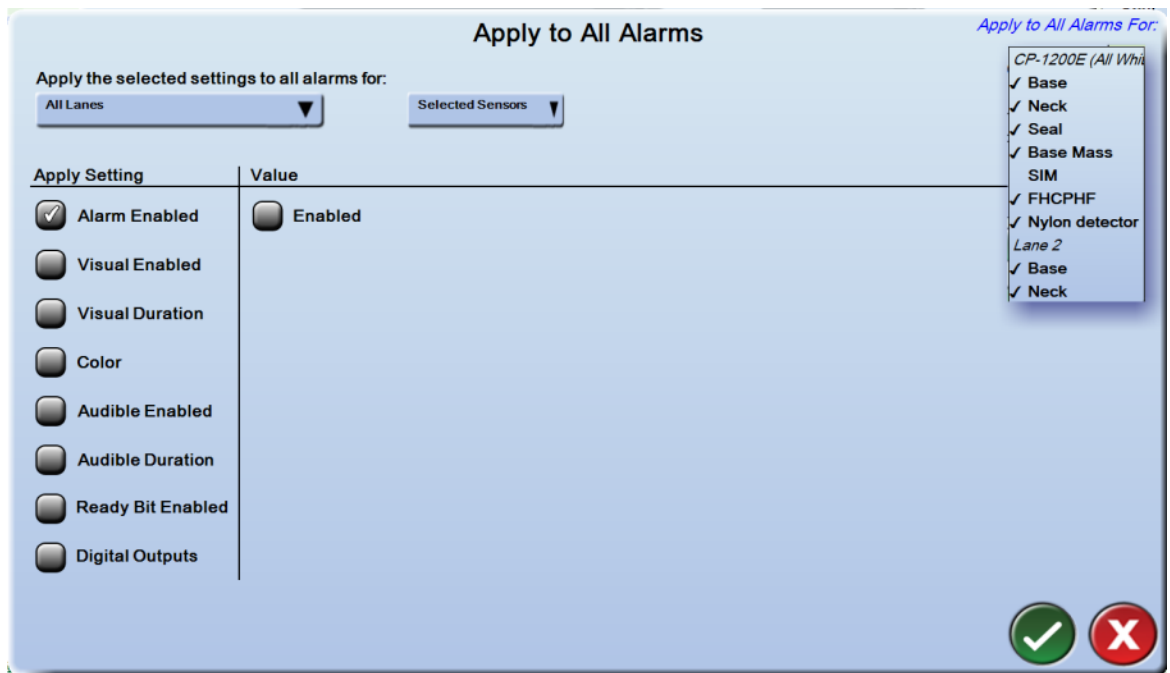

Exclamation Sign or Warning Displayed on Alarms Button

If you see a small exclamation sign over the Alarms button, this means that a count-only alarm was triggered. See:

- [Lane Alarm Configuration](#) - Lane Alarm Configuration
- [System Error alarm details](#) - Sensor Alarm Configuration
- **Missed Reject / Missed Result** in "[Rejector Alarms Configuration](#)" on page 55 (**Details** button next to Alarm Enabled, which cannot be modified for these alarms).

Rejecting

Reject Enable/ Disable for Multiple Sensors within a Lane

To enable or disable the rejector for one or more sensors within a lane:

1. From Lane Overview or Sensor Overview mode, select Tools  | Lane Setup | Rejecting | Rejector Enable/Disable.
2. Check or un-check the box next to the sensor(s) to enable or disable the rejector.

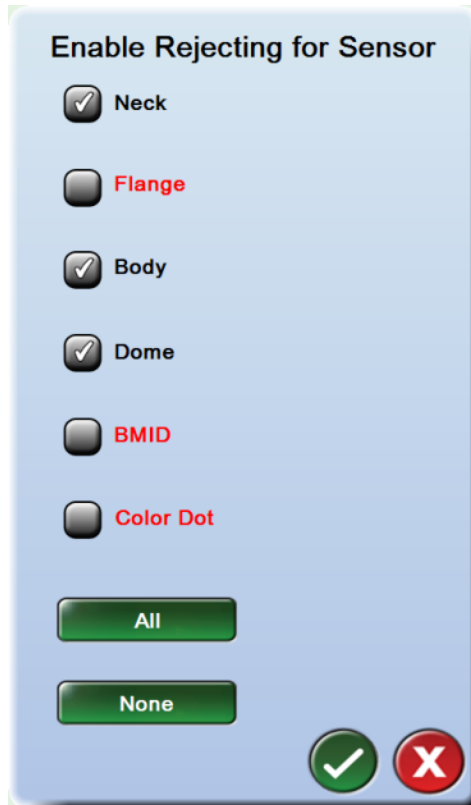

✔ Select the OK button to save changes and exit. The new setting is applied.

If a rejector is disabled, the sensor name is displayed in red instead of white.

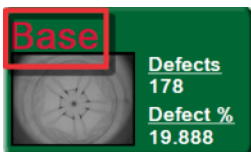

If the rejector for all sensors within the lane is disabled, you will see the trash can icon near the statistics for that lane.

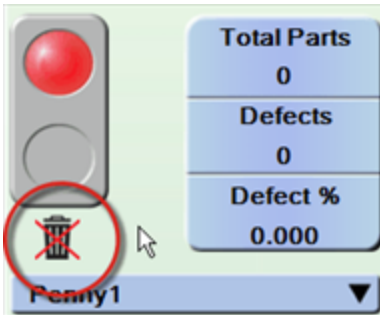

Note: the trash can symbol is only displayed if ALL sensors within the lane are disabled.

If you put the system online when the lane rejectors are disabled, you will see a message stating "Lane Rejector Disabled - Do you want to go online?" You may select Yes and continue online.

Reject Enable/ Disable for Sensor Only

If the system is rejecting excessive parts, you can quickly disable the rejecter for that sensor.

To enable or disable the rejecter for one sensor only:

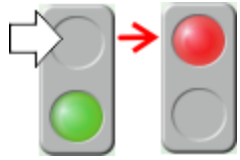

Take the lane offline.

From Sensor Overview mode | right-click over the sensor button | **Rejecting** | uncheck **Sensor Reject Enabled**.

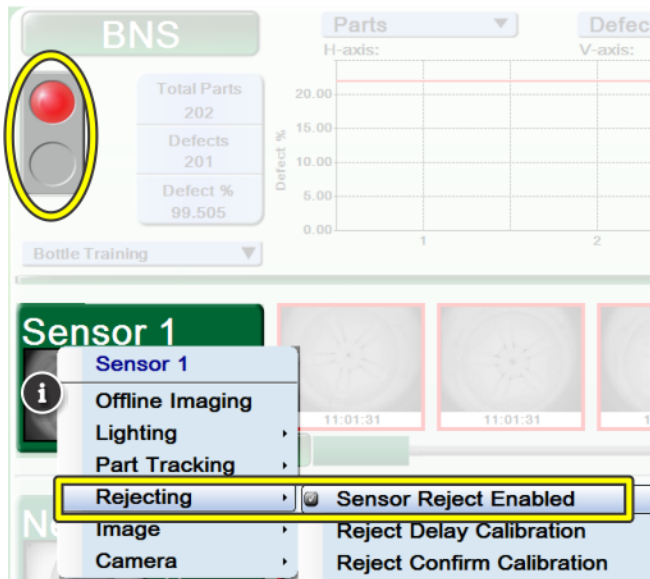

This toggles to **Sensor Reject Disabled**. Red text = disabled.

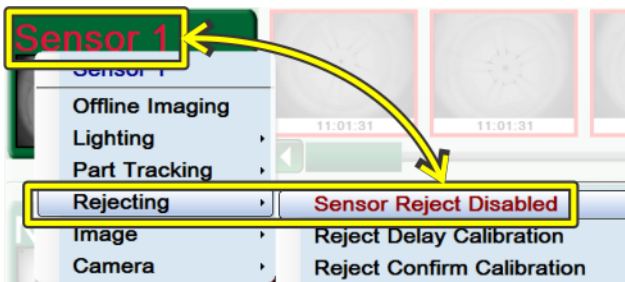

If you put the system online when the Sensor rejector is disabled, you will see a message stating "Sensor Rejector Disabled - Do you want to go online?" You may select Yes and continue online.

Forced Rejects Utility

To get to this screen: From Lane or Sensor Overview mode, select Tools  | Lane Setup | Start Forced Reject.

Note: the lane must be Online to force rejects

Exiting the Forced Rejects utility will not stop the forced reject process. Use the **Stop Forced Rejects** button.

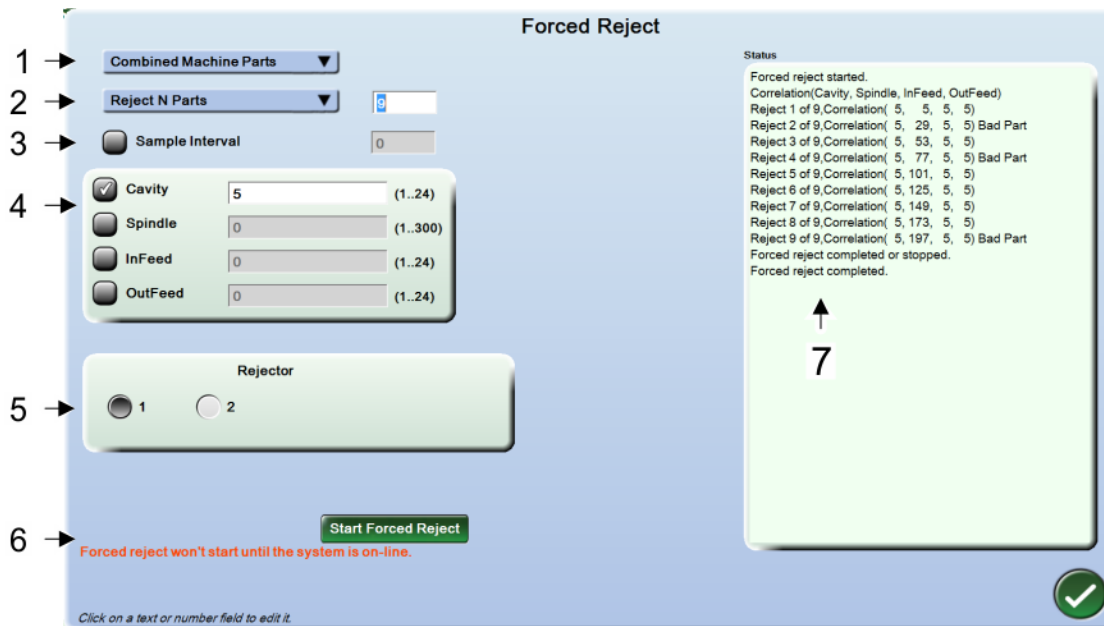

- 1 - Any Part/ Single Machine Part/ Combined Machine Parts (drop-down menu)
- 2 - Reject one part, 'N' parts, or continuously reject from a specific machine part.
- 3 - Sample Interval - Only reject parts every n number of intervals.
- 4 - Select Machine Part
- 5 - Rejector - Specify which rejector to force rejection of the part.
- 6 - Start Forced Reject/ Stop Forced Reject
- 7 - Status Box - Displays information about the rejection process.

System Tools

Machine Part Correlation

Configure up to four parts for correlation.

Note: this screen is usually set up by the Pressco installer

To get to this screen: From Lane or Sensor Overview mode, select Tools  | Lane Setup | Machine Part Correlation.

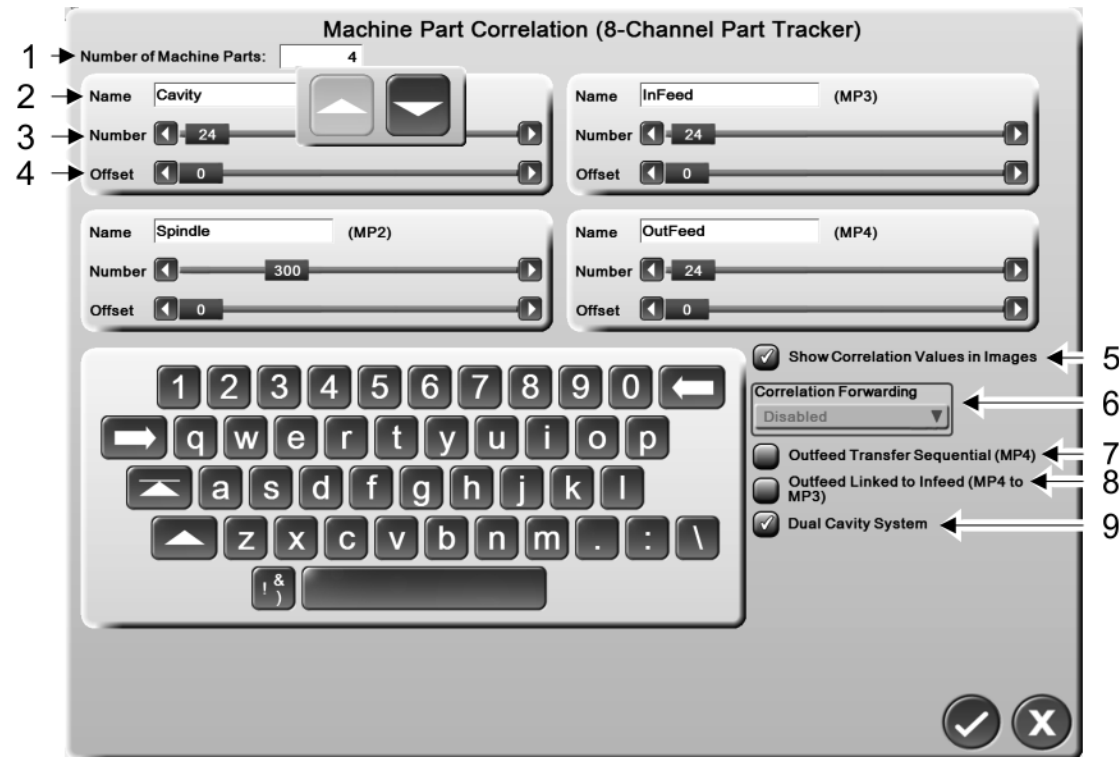

1 - **Number of Machine Parts** Select the number of correlation sensors in your system (1-4). Note: If you only see two Machine Parts, you probably have a two channel Part Tracker board. This is the default configuration. If your system has an eight channel part tracker board, you must run the Discovery software and configure the lane for an eight channel part tracker board. Use the Edit Existing Lane function. This will provide the capacity for four Machine Parts to be configured.

2 - **Name (correlation)** Name each machine part to something recognizable to you (examples: Cavity, Spindle, or Liner Gun #1). This name is displayed on the Intellispec screens and throughout correlation reports.

3 - **Number** Set the number of components in each machine part (example, number of pockets in a starwheel).

4 - **Offset** Change what the inspection system considers part #1 (or pocket #1) and the actual part. For example, if you reject a part from cavity #1, and the system rejects the part from cavity #2, then set the offset at 1. This ensures the inspection system tracks components properly.

5 - **Show Correlation Values in Images** Displays the correlation value in the images. These values are saved as part of the image file (if



you save images).

6 - **Correlation Forwarding** This feature takes correlation information from one lane of inspection (slave lane) and forwards it to another lane (master lane). This is used when one lane has software correlation (inspections) set up, and the other lane does not. See also **Correlation Forwarding** topic in Intellispec software guide.

7 - **Outfeed Transfer Sequential** (Only when four sensors are used, and only in blow molder installations) Specify whether the infeed and outfeed transfer arms are numbered Independently or Sequentially.

Example of Outfeed Transfer Sequential

For example, your machine has 10 infeed transfer arms and 10 outfeed transfer arms. If they are numbered Independently, the infeed transfer arms are numbered 1 - 10, and the outfeed transfer arms are also numbered 1 - 10. If they are numbered Sequentially, the infeed transfer arms are numbered 1 - 10, and the outfeed transfer arms are numbered 11 - 20.

8 - **Outfeed Linked to Infeed (MP4 to MP3)** (Only in blow molder installations) Enable this to derive the outfeed correlation count (MP4) from the infeed correlation count (MP3). This is typical of most blow molders

Example of Linked to Infeed

For example, in an SBO20 machine, the infeed count will be from 1 - 10. The outfeed count will be from 11 - 20. Infeed count 1 will correspond to outfeed 11, and so forth.

Note: When this feature is enabled, the number of components is forced to be equal (number of components in MP3 = number of components in MP4).

Note: There is no index sensor for MP4 in the hardware configuration.

9 - Dual Cavity System - no function at this time.

Support Package

Create a Support Package

A support package is a set of files gathered by the Intellispec system to help find system problems. You will send this package to Pressco service specialists so that they can troubleshoot your system. This file can also back up your system configuration (not the entire system database).

Note: On rare occasions, the Intellispec software cannot be started, so you will not be able to access the support package tool from the user interface. It is possible to create the support package without Intellispec running by starting the following executable from Windows: C:\Pressco\bin\SupportPackaging.exe.

What you need:

- USB flash drive (128MB or larger). Connect this to the USB port
- If you have a ".pcf" file from a Pressco Support representative (to acquire additional system information), then copy that file to the USB drive prior to connecting it to the Intellispec system
- If you want to save images to send with the support file, then save images prior to creating the support file. Be sure to save them in the default image folders: C:\Pressco\Lane n\Images\Sensor n. See Saving Images.

To create the support package:

1.  Select the Backup and Restore Menu | **Create Support Package**. The support package wizard is displayed.
2. (optional) At Step 1: Configure: add the ".pcf" file or images.

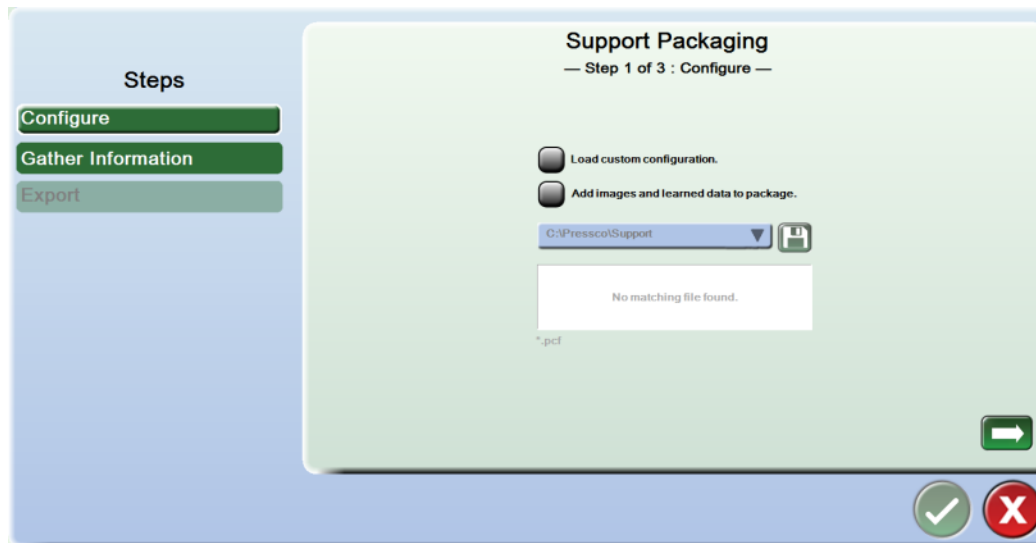

3. (optional) Check the **Load custom configuration** box. A .pcf file is a custom Pressco configuration file that gathers information beyond the standard Support Package. If a Pressco Support representative sent you a .pcf file, then connect the USB device that contains the .pcf file. Select the disk icon and browse to the location (USB drive) where the .pcf file is stored. The system locates the .pcf file.
4. (optional) Check the **Add images and learned data to package** box. A dialog (shown below) allows you to choose the type of images to include.

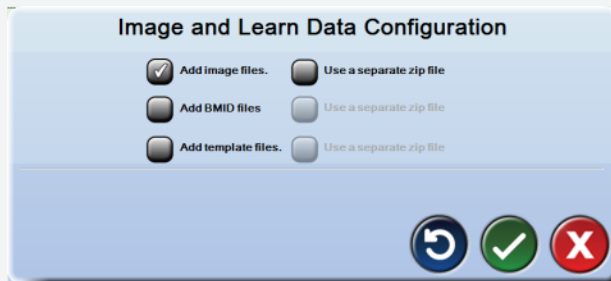

- **Add image files** select images in the default image folder (example: C:\Pressco\Lane 1\Images\Sensor 1). All sensors and lanes for which you have images are included.
- **Use a separate zip file** a zip file with "IMAGES" in the name is created along with the Support Package zip file. All sensors and lanes for which you have images are included. If you do not check this box, then the images are included in the main Support Package zip file.
- **Add BMID files** if you have an inspection using BMID correlation, the images from the BMID folder are included (example: C:\Pressco\Lane 1\BMID).
- **Add template files** if you have a Template Registration or Template Orientation inspection, the images from the InspectionTemplates folder are included (example: C:\Pressco\Lane 1\InspectionTemplates).

5. Follow the instructions on screen. Use the forward arrows  to move to the next screens.
6. When the steps are completed, verify that the **Step 3: Export** screen is displayed.

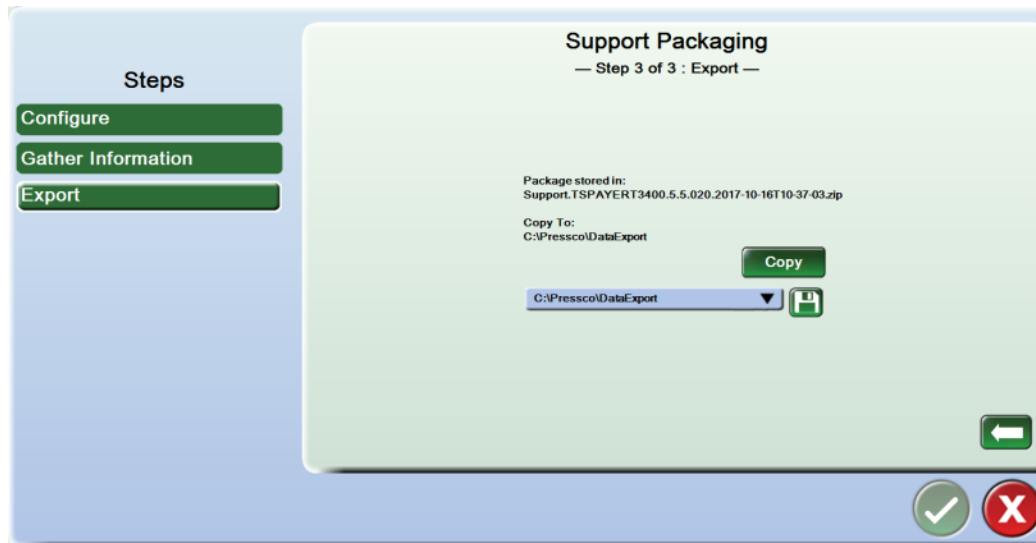

7. Select the USB Flash Drive in the "Copy to:" location.
8. Select the **Copy** button. The support package files are copied to the USB flash drive, then a "Copy Succeeded" message is displayed.

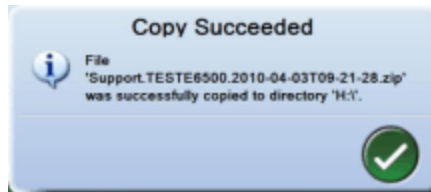

9. Select the OK button to continue.
10. Select the OK button at the bottom of the Support Packaging screen to exit.
11. Remove the USB flash drive.
12. Copy the files that were saved, including images, from the USB drive to your computer.
13. Send an e-mail to techsupport@pressco.com and attach the support package files. Pressco service/ tech support will respond within one business day, if possible.

Restore From Support Package

You can restore (import) a support package to a working Intellispec system. This allows you to use the same configuration on multiple systems without having to duplicate your efforts, or use a known good configuration created on another system or by Pressco Technical Support.



What you need:

- A USB flash drive with a known good support package on it
- Mechanical keyboard to enter a problem description (if backing up your current configuration)

To restore the support package:

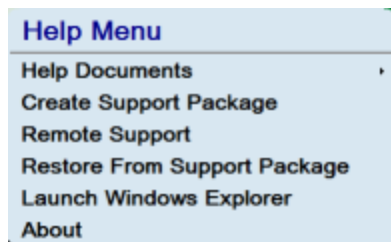
1. Select Home  | Help  | **Restore from Support Package**.



2. The system will suggest that you back up your current system. We recommend that you select the **Create a Support File** button to back up the system.
3. Follow the instructions on screen, and select the location of the USB drive that contains the support package you want to restore, when prompted.
4. Select the support package from the USB drive that you want to restore.
5. Use the forward arrows  to move to the next screens.
6. When the system says "Series V Application detected," select the **Stop Application** button to shut down the Intellispec software. This is necessary to restore the support package.
7. At step 4 on screen, select the **Unpack Zip File** button to restore the support package and wait for the system to unpack the files.
8. When the system says "Unpacking Complete," select the forward arrow  to move to the next screen.
9. Select the **Restart Discovery** button to restart the Intellispec application.

Save Images

There are several ways to save an image within the Intellispec system.

Save any image:

In most parts of the system, right-click over any image. Follow the instructions on screen. This is useful to save images to include with a Support Package.

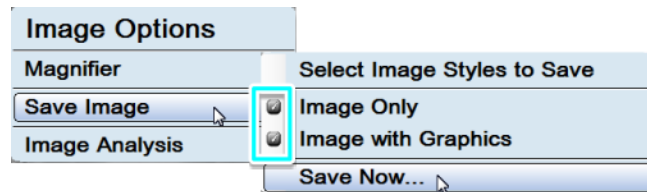

✓ = enabled. Then click **Save Now...**

Image Only - bitmap (.bmp) image with no graphics. Note: only bitmap images can be loaded back into the Intellispec.

Image with Graphics - portable network graphic (.png) image with inspection graphics

The image is saved to the default location shown, unless you specify a different location. A default file name is provided for you. Select the keyboard icon to rename the image.

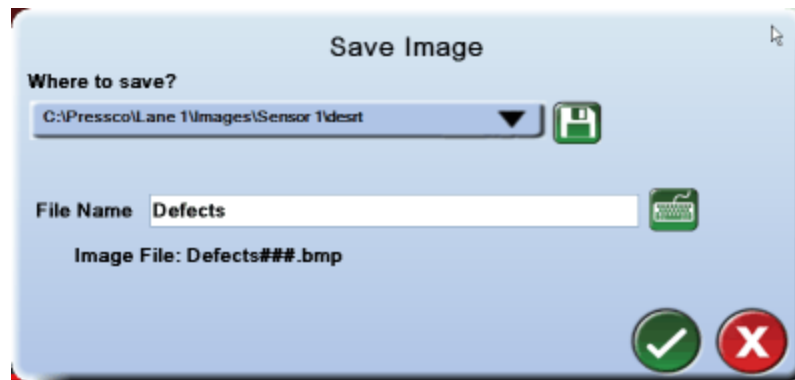

Find information about other methods of saving images through the links below:

["Save Images Through the Sensor Menu" on page 81](#)

["Auto-Save Images" on page 82](#)

["Save Images through the Retro-Spec interface" on page 84](#)

["Save Individual Images While Editing an Inspection" on page 87](#)

["Save Reject Images" on page 88](#)

"Save a Region of Interest (Unwrapped) Image" on page 89

Save Images Through the Sensor Menu

Save a set of images from one sensor (up to 100 images). You can save images whether the lane is online or offline. Right-click to see the menus.

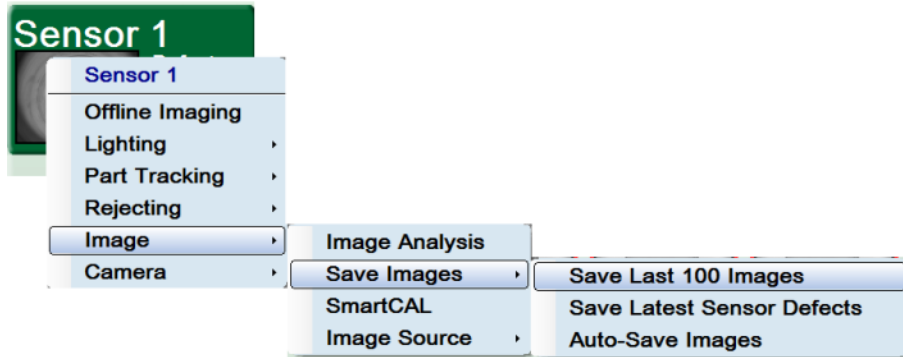

Save Last 100 Images Save the last 100 images captured by the current sensor.

Save Latest Sensor Defects Save the latest defect images shown in the Reject Images thumbnails, up to 100 images.

See also "Auto-Save Images" on the next page

Auto-Save Images

Save up to 1000 images from one sensor when the lane is online. To get to this menu: Right-click a sensor button | **Image** | **Save Images** | **Auto-Save Images**.

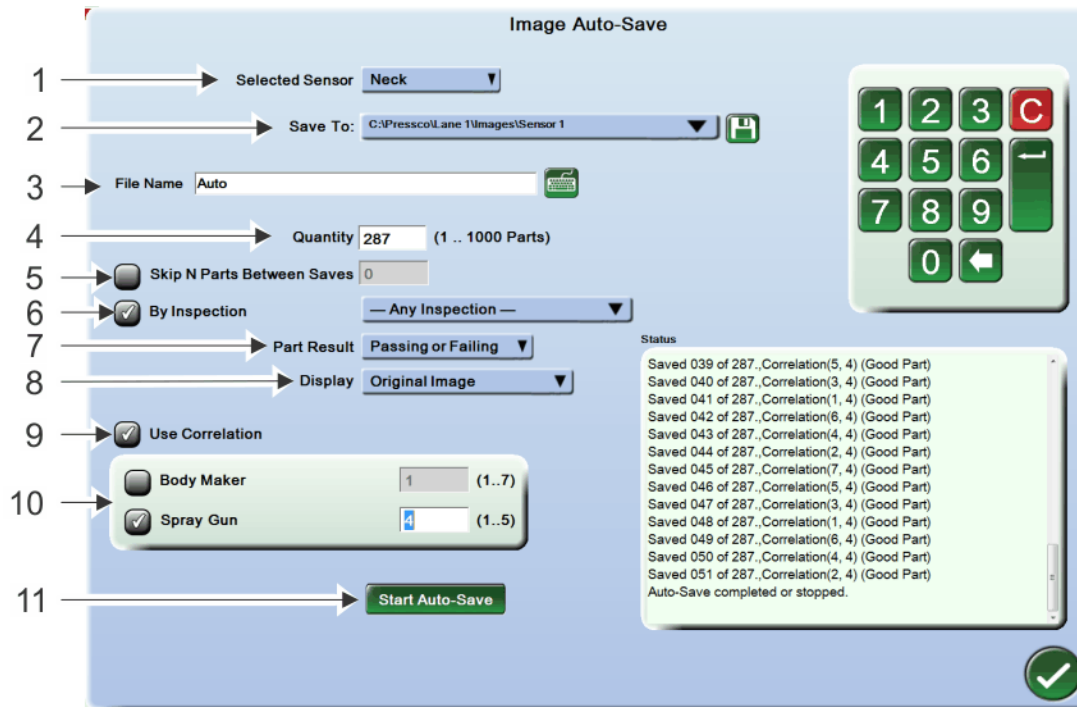

1 - **Selected Sensor** Select one or all sensors.

2 - **Save To** Select the location. To change the location, select the disk icon  and browse to the desired location.

3 - **File Name** Create a file name, descriptive of the part you are inspecting. The system automatically adds numbers and letters to the name. Example: "Auto0001_S1_P.bmp." [0001] = image 1. [S1] = Sensor 1. [P] = part passed. [F] = part failed.

4 - **Quantity** Quantity of images to auto-save, up to 1000.

5 - **Skip N Parts Between Saves** Check the box if you do not want to save consecutive images. Enter the number [N] of parts to skip between saved images.

- 6 - **By Inspection** Only available when you have one sensor selected [in item 1]. Save images related to an inspection. Use the drop-down menu to select the inspection from the current part program.
- 7 - **Part Result** Save images that pass or fail inspection, or both. When images are saved, the file name contains [P] for passing or [F] for failing.
- 8 - **Display** Save the original image from the camera, or the image after centering, or the image after centering and orientation.
- 9 - **Use Correlation** [available if correlation is installed] Save images correlated to specific machine parts.
- 10 - **Machine parts** [available if correlation is installed] Select the machine part(s) to save images from. Also enter a machine part number in the box provided.
- 11 - **Start Auto-Save** Select Start Auto-Save to start saving images. Select Stop Auto-Save to stop the process. The lane must be online to collect images.

Save Images through the Retro-Spec interface

[1] Unlock, [2] drag image to disk [3]. Choose where to save the image.

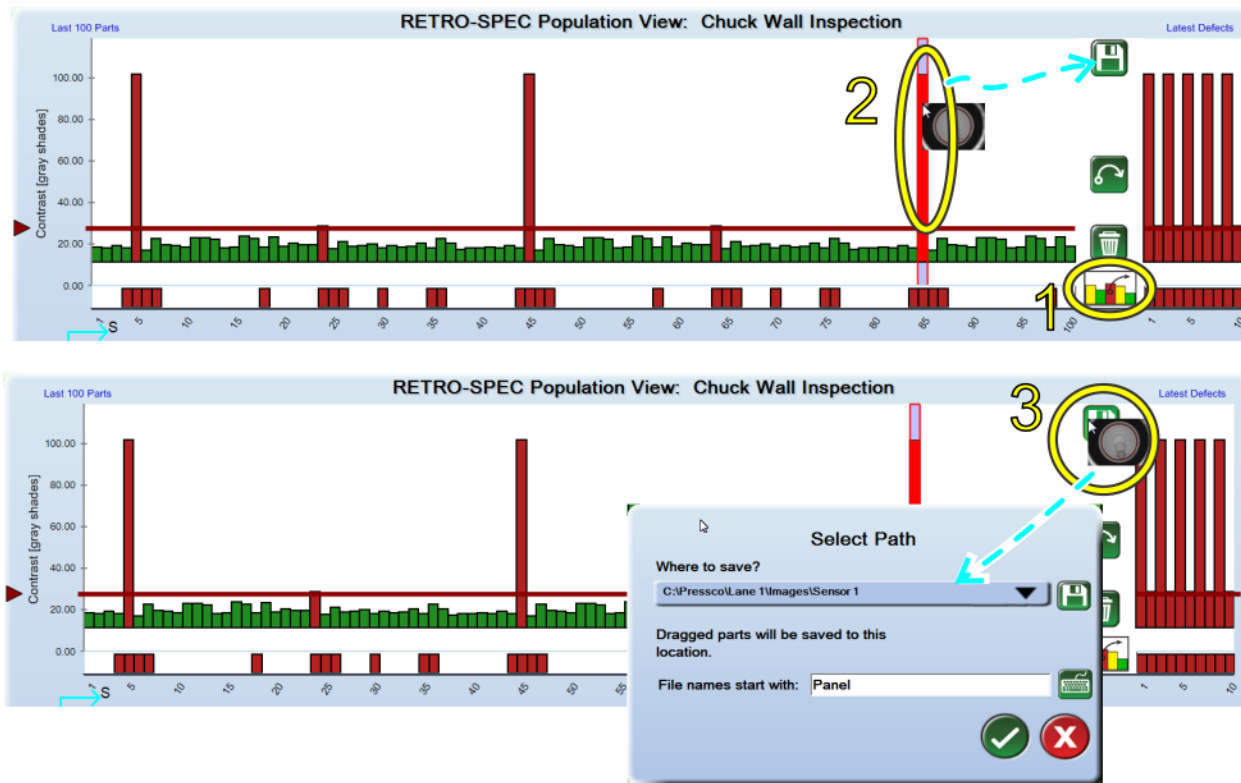

Later, you can load the saved images for setting up a part program or testing.

Recommendations for Image File Management

When you save the images for data sets to a folder, each image is given a unique name. Those original images are overwritten if you save images again. We recommend that you create new folders when you save images. Our recommendations are:

- Make new folders and give them meaningful names
- Add the word **Defects (or Good)** to the folder name to indicate that you are storing defects (or good images) for that inspection

When you are saving images, you can create new folders (directories).

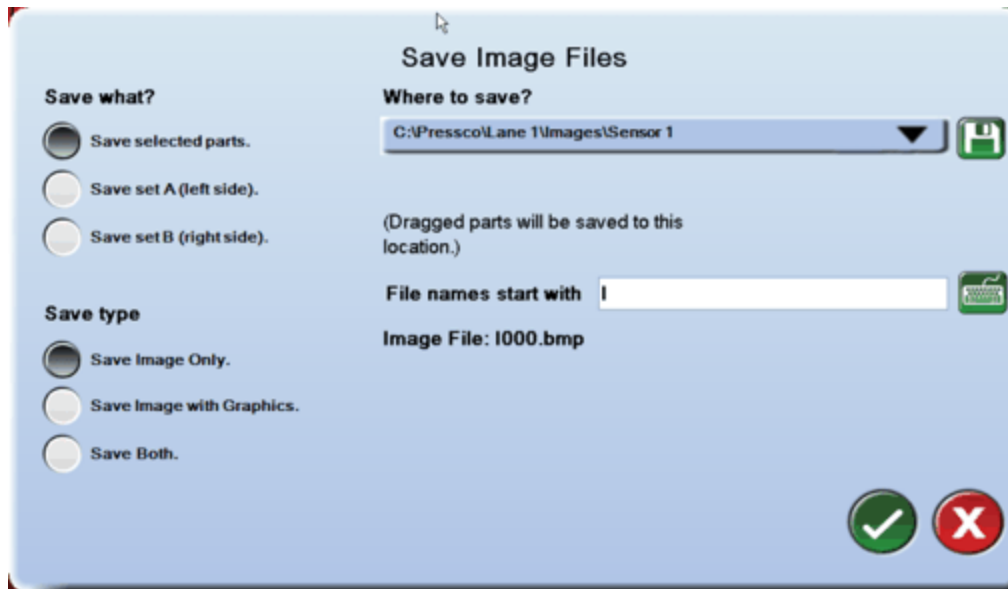

To create a new folder while saving images:

1. Select the disk icon  on the Retro-Spec graph.

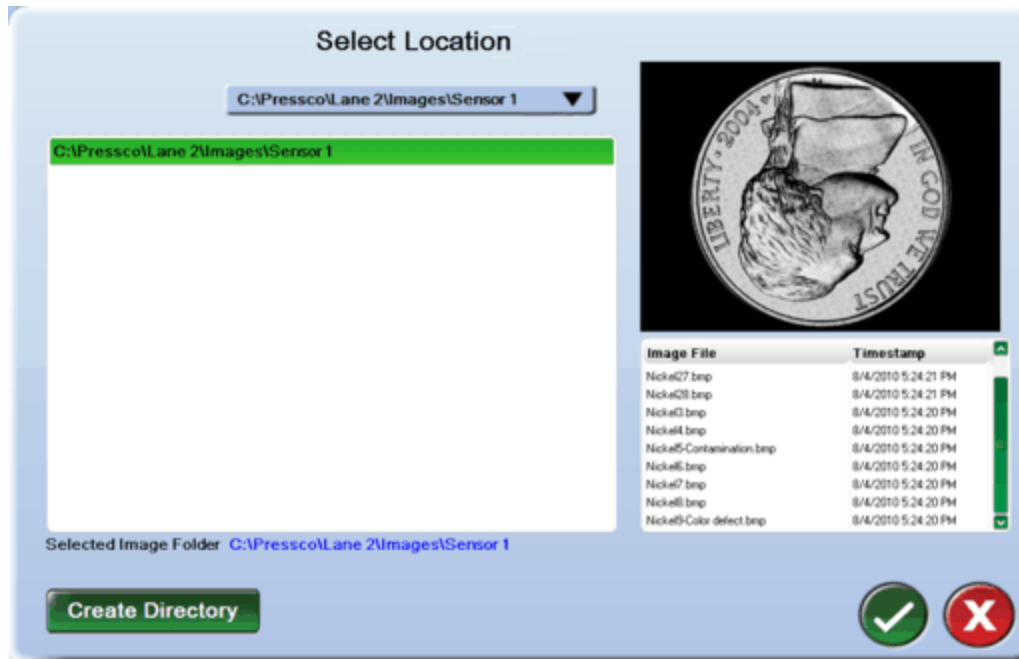

2. Select the disk icon  to browse folders. The **Select Location** menu is displayed.



3. Select the button at the top of the menu to browse to the location for the sensor (example, "C:\Pressco\Lane 1\Images\Sensor 1"). Note that you can also save images to a USB device.
4. Select the **Create Directory** button to create a new folder. Rename the folder something meaningful (example, sidewall). If you are saving images of defects, use Defects in the folder name.
5. Select the OK  button to complete browsing and return to the Save Image Files menu.
6. Select the OK  button to save the images. Depending where the images are being stored, it may take up to a minute to complete, especially if a USB device is used.

Save Individual Images While Editing an Inspection

Right-click over the image | Save Image | choose the desired option. The image can be saved whether the lane is online or offline.

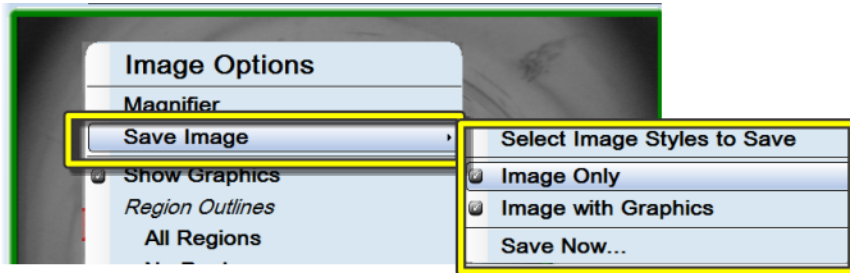

Save Reject Images

Save up to 100 (*.bmp) images from defective parts. The lane can be online or offline.

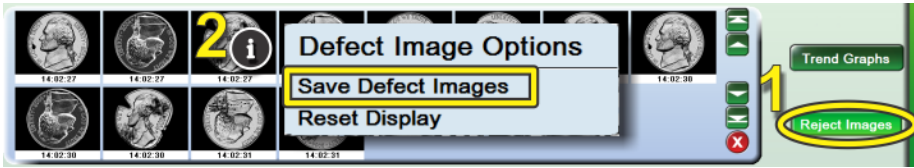

Reset Display Resets the reject image display to show all failed parts, instead of images from only one part or one inspection.

Save a Region of Interest (Unwrapped) Image

Save the unwrapped region display while you are editing an inspection. The image can be saved whether the lane is online or offline. The image is saved as a .png file.

*Note: if you want to save graphics with the image, you must **Show Graphics**.*



Loading Saved Images

You can load saved images through the Retro-Spec interface. These images can be used to test part programs, or to set up a part program without the production line running. See also how to choose an Image Source through the Sensor menu.

The screenshot displays the RETRO-SPEC Population View interface for 'Curl Dimension [Contrast Limits]'. The background shows a bar chart of contrast values for the last 100 parts. Overlaid on this are two dialog boxes: 'Select Data Sets' and 'Select Folder'. The 'Select Data Sets' dialog has two columns, 'Set A (left side)' and 'Set B (right side)', each with radio button options: 'Nothing Selected', 'No Changes (keep current parts)', 'Last 100 Parts', 'Latest Defects', 'Freeze-on-Defect Locked Image', and 'Image Files'. A path 'C:\Pressco\lane 1\images\Sensor 2\Defect' is shown below. The 'Select Folder' dialog shows a file tree with 'Sensor 1' selected under 'Images'. A table of 'Image File Time Stamp' is visible in the bottom right of the 'Select Folder' dialog.

Image File	Time Stamp
1	7/30/2009 3:08:47 PM
10	7/30/2009 3:08:47 PM
3	7/30/2009 3:08:47 PM
4	7/30/2009 3:08:47 PM

Lighting and Imaging

Pressco Inspection Theory

Introduction to Pressco Inspections

What is a pixel? Pixel (picture element) is the smallest part of a digital image

X/Y Location All pixels have an X/Y location in an image.

Grayscale The measured brightness of a pixel from 0 to 255

- 0 = black, the absence of light
- 255 = white, saturated with light

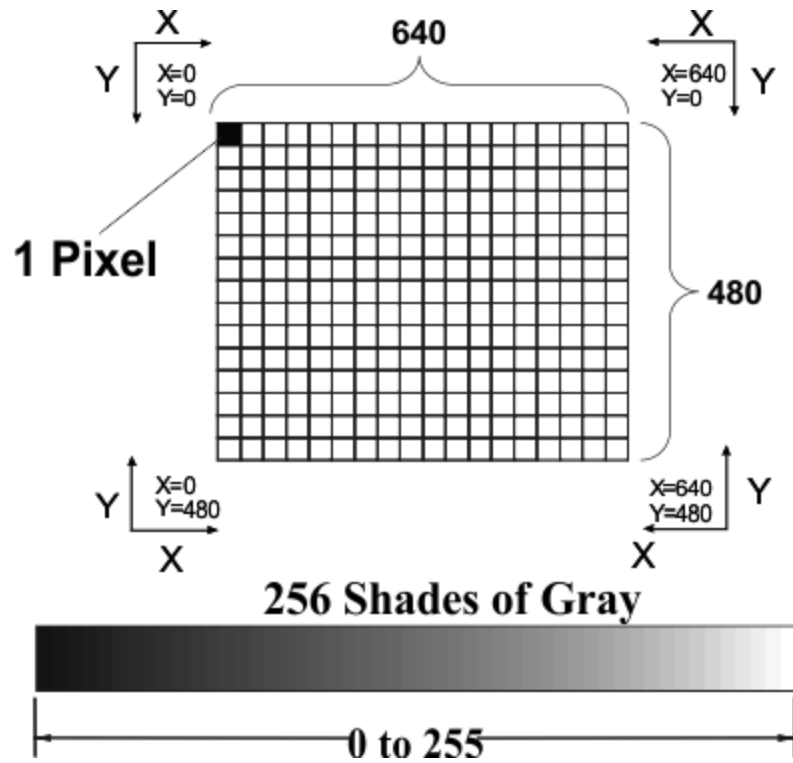

Pixel Grayscale Values

255

255	254	253	252	251	250	249	248	247	246	245	244	243	242	241	240
239	238	237	236	235	234	233	232	231	230	229	228	227	226	225	224
223	222	221	220	219	218	217	216	215	214	213	212	211	210	209	208
207	206	205	204	203	202	201	200	199	198	197	196	195	194	193	192
191	190	189	188	187	186	185	184	183	182	181	180	179	178	177	176
175	174	173	172	171	170	169	168	167	166	165	164	163	162	161	160
159	158	157	156	155	154	153	152	151	150	149	148	147	146	145	144
143	142	141	140	139	138	137	136	135	134	133	132	131	130	129	128
127	126	125	124	123	122	121	120	119	118	117	116	115	114	113	112
111	110	109	108	107	106	105	104	103	102	101	100	99	98	97	96
95	94	93	92	91	90	89	88	87	86	85	84	83	82	81	80
79	78	77	76	75	74	73	72	71	70	69	68	67	66	65	64
63	62	61	60	59	58	57	56	55	54	53	52	51	50	49	48
47	46	45	44	43	42	41	40	39	38	37	36	35	34	33	32
31	30	29	28	27	26	25	24	23	22	21	20	19	18	17	16
15	14	13	12	11	10	9	8	7	6	5	4	3	2	1	0

0

Examples of Grayscale

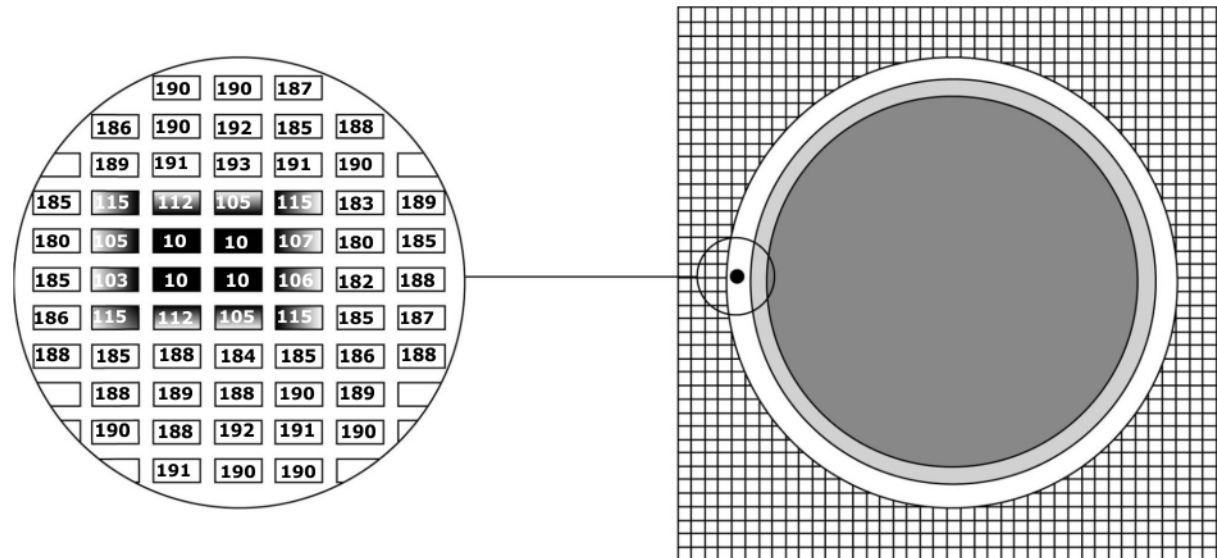
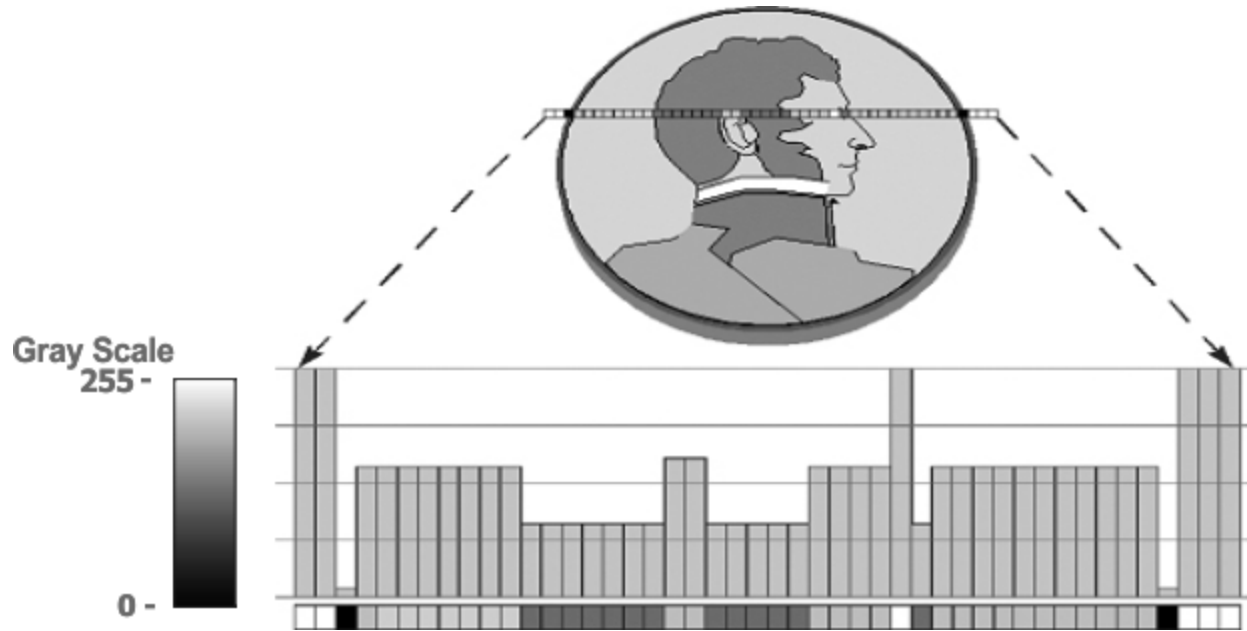

Gradient

The difference in gray shades between pixels being compared.

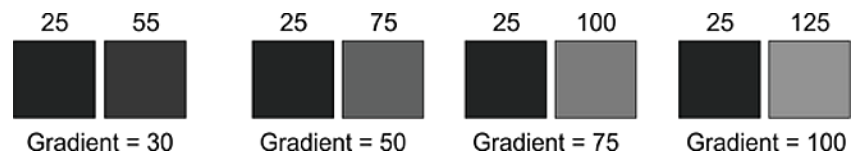

The illustration below shows the same gradient values as above, but displayed as an example 'defect.' In each case, the background is the same - 25 gray shade.

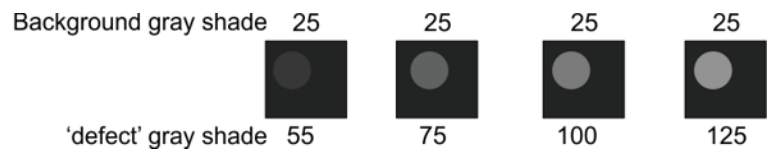

Delta

The distance between pixels being compared. Higher delta = greater sensitivity.

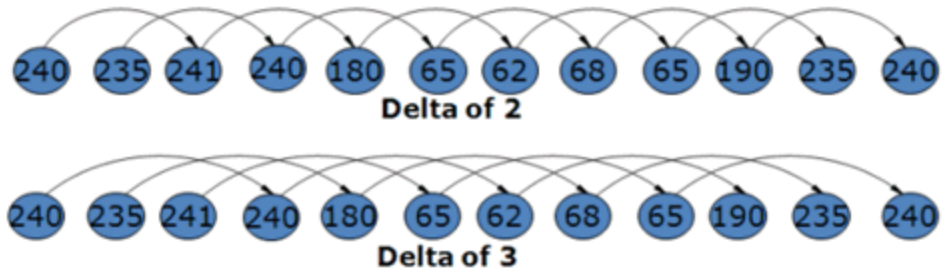

Size

The number of pixels in a group being compared. Greater size = lower sensitivity.

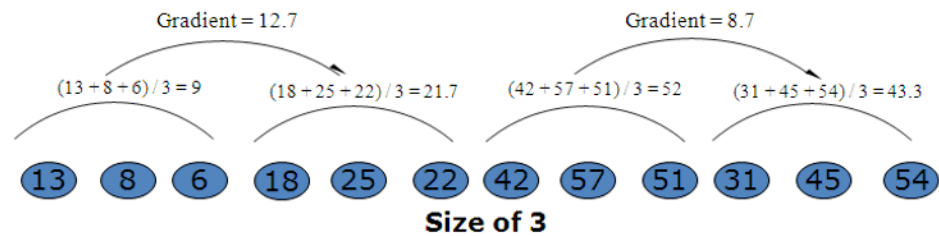
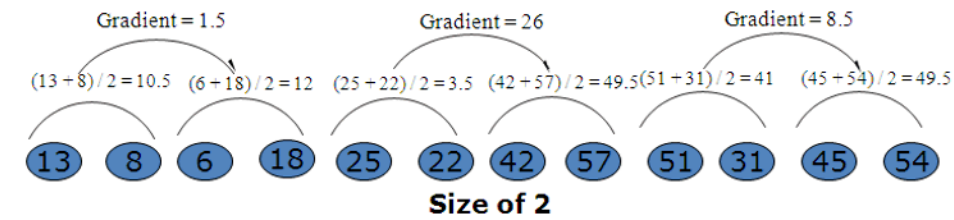

Part Tracker Simulation

Used for troubleshooting. A simulated part rate allows inspection to continue.

To get to this screen: From Lane or Sensor Overview mode, select Tools  | **Hardware Setup** | **Part Tracker Simulation**.

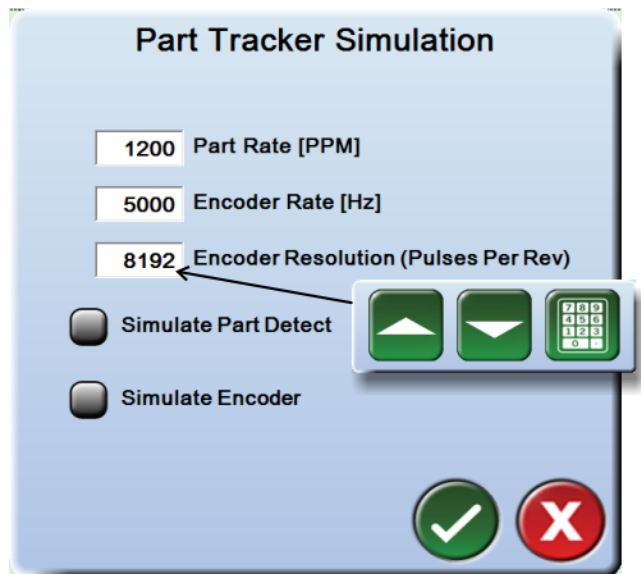

To enable the simulated part tracker, select the check box and then enter the desired part rate in the window.

Part Rate - Enter a simulated part rate in parts per minute (PPM).

Encoder Rate and Resolution - Enter the simulated encoder properties.

Note: the system cannot run in both PDX mode and Part Tracker Simulation mode at the same time. If one mode is already running and you enable the other mode, the system displays a warning that the latest setting will override the previous mode.

Imaging

Offline Imaging

Acquire images when the lane is offline. To see this menu, right-click over a sensor button, then select **Offline Imaging**.

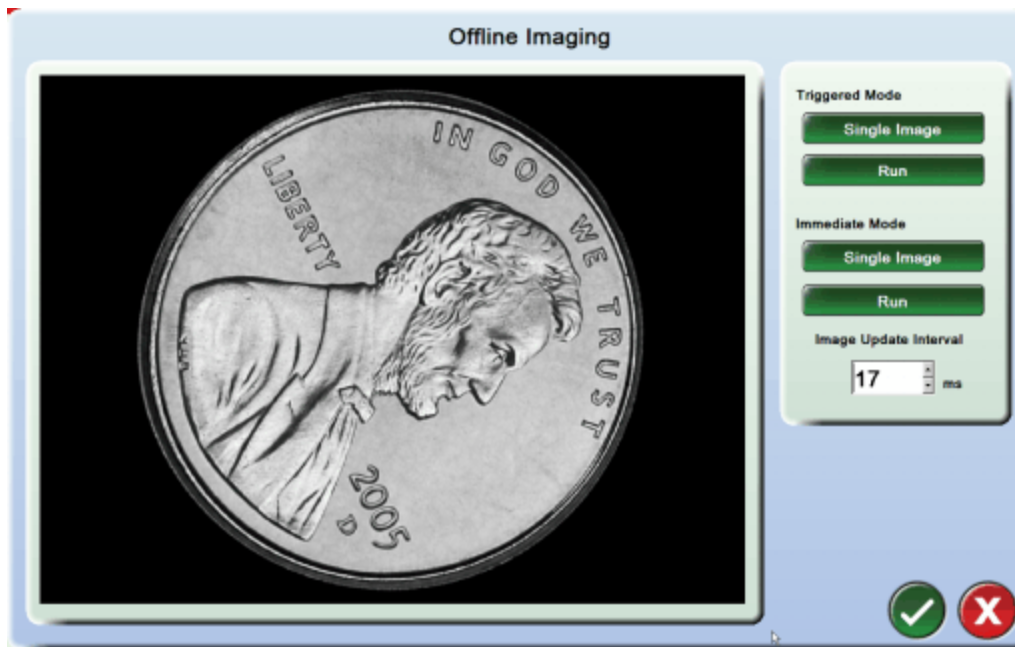

Triggered Mode

Single Image a picture is taken every time the button is clicked. (it uses the part detector)

Run pictures are taken continuously as each part triggers the part detect sensor.

Immediate Mode

Single Image a picture is taken every time the button is clicked. (it does not use the part detector)

Run the camera takes continuous pictures, using the "Image Update Interval." You see whatever is under the camera.

Image Analysis

Measure the gray shade value, or distance between, pixels in your image. This is available offline only.

Note: to quickly measure a gray shade in an image, use the Image Magnifier instead (click or right-click an image).

To get to Image Analysis: Make sure the lane is offline. Right-click a sensor button | **Image** | **Image Analysis**.

Image Analysis for Sensor 'Body'

Marker Pool: (s: 0 = 104; □ = 263; Distance = 159) Marker Value Difference: (□ - □) = 5 Marker Values: □ = 163; □ = 158

C: Area=20016 Circle | center=182, Avg=119, Range=99, STD=10.995, Angle=104.442°, Center=(200, 248)
 C: Area=20016 Circle | center=182, Avg=119, Range=99, STD=10.995, Angle=104.442°, Center=(200, 248)
 C: Area=20016 Circle | center=182, Avg=119, Range=99, STD=10.995, Angle=104.442°, Center=(200, 248)
 Calibration: Circle Diam ser=182.00 Measured Diameter=14.00, Computed Scale=0.8022
 Calibration: Circle Diam ser=182.00 Measured Diameter=14.00, Computed Scale=0.8022
 Calibration: Circle Diam ser=182.00 Measured Diameter=14.00, Computed Scale=0.8022
 L: Line Length=902 Au =148, Range=88.250, STD=47.058, Point 1=(400, 248), Point 2=(100, 248)

Measured Length: mm

Calibration Units: millimeters [mm]

Calibration Scale: 0.8022 millimeters / pixel
1.2466 pixels / mm

1 move

2 get more images

Measure area
a - move area
b - resize area

Camera Resolution: 640 x 480 Monochrome

Calibrating the Image Pixel Scale

Using Image Analysis

Image Analysis can be used to enter your actual measured values of your part and compute the units of measure per pixel. This is called Pixel Scale. This calibration can be used for any inspection on that sensor.

To compute the pixel scale:

1. Using a known good part, measure the length or diameter of an area on your part.
2. Enter that value into the **Measured** box.
3. Place a line or circle on the part image in Image Analysis over the same location used to measure your part. Place the markers of the line, or a circle at the edges where you want the system to measure your part.
4. Click the **Compute Scale** button. The system computes the pixel scale and displays the values.
5. To save the scale to the Sensor file, click the **Save Scale** button. The pixel scale is saved with the sensor and can be used for any inspection on that sensor.

Using an inspection

Pixel scale can be calibrated for an individual inspection or sensor. When **Save Calibration** is used in these inspections, you can use the calibrated information in other inspections for that sensor. The inspections that perform pixel scale calibration are:

- Measurement
- Fill Height
- Fill Height - Segmented
- Neckring Registration
- Distance

Select Measurement Unit (Review Camera Calibration)

Select a measurement unit. If you switch between inches and millimeters, the pixel scale is automatically converted. Calibration to pixel scale is performed in Image Analysis or some inspections such as Measurement or Fill Height. Calibration is used to compute measurements on a part.

The unit you select in this menu is displayed in the Inspection menus: **Ⓟ** for pixels, mm for millimeters, " for inches, or [] blank for custom units.

To get to this menu, right-click over a Sensor button | **Camera** | **Review Camera Calibration**.

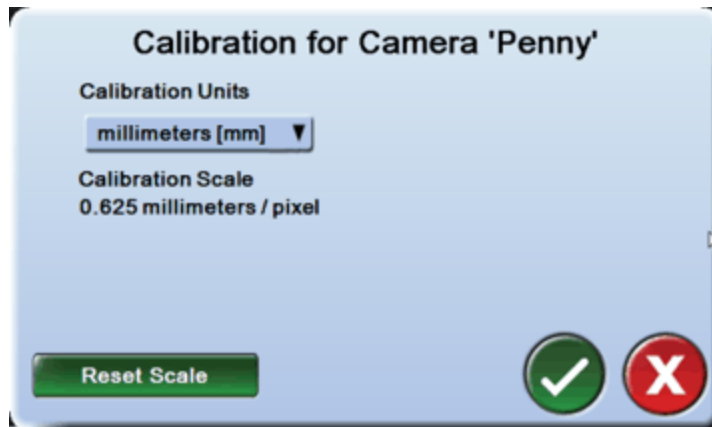

Notes:

- If you switch from mm to inches or the opposite, the scale is converted for you. However, if you switch to custom or pixels between mm and inches, then the scale is not adjusted for you.
- If you switch to pixels, the scale is set to 1.0. The scale will revert back to your calibrated value if you switch from pixels to another unit.
- The **Reset Scale** button sets the scale to 1.0 for any unit you have selected.

Lighting

Lighting - access

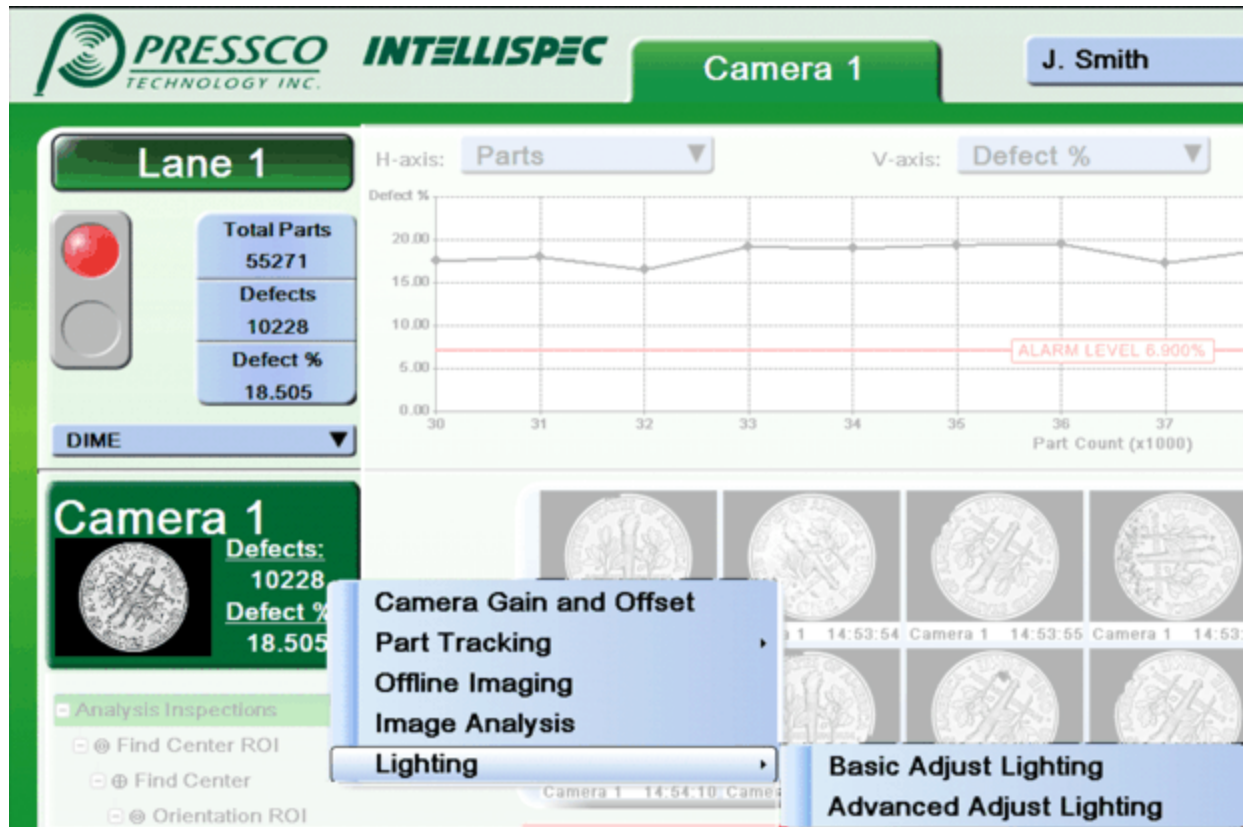
**To access the lighting software:**

1. From Lane Overview mode, right-click on the desired sensor button.
2. Select **Lighting**.
3. Select **Basic** or **Advanced** lighting. For most adjustments, Basic lighting is adequate. Advanced Adjust lighting is used by Pressco engineers or for making infrequently performed specialized settings.

Basic Adjust Lighting

Basic lighting provides most of the lighting adjustments you will use. Lighting must be adjusted while the lane is offline.

To get to this screen: Right-click over a sensor button | **Lighting** | **Basic Adjust Lighting**.

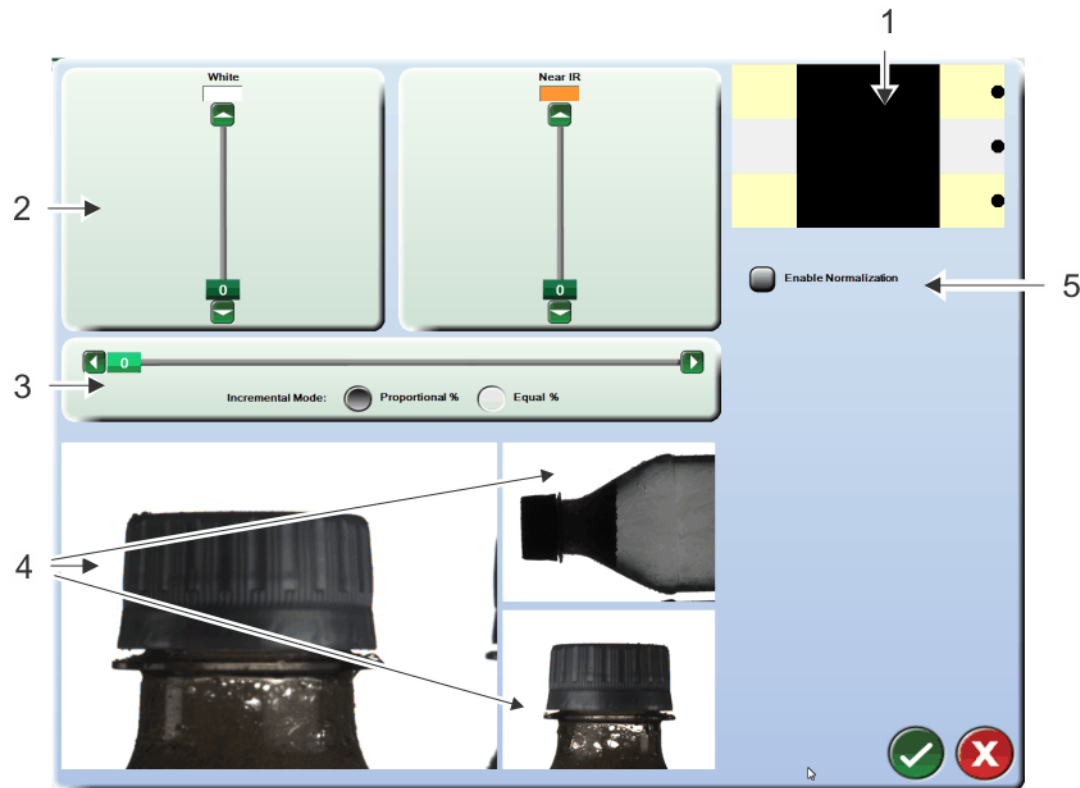

1- Select a zone to adjust it. You can select a single zone or multiple zones. As lighting is changed, the zone and the button next to it change color.

2 - Separate slider bars for each color (red, green, blue, and infrared) allow individual adjustment.

3 - **Proportional %** - Moving the slider bar adjusts all colors but maintains the current percentage of each color. **Equal % lighting** - Each color is adjusted by the same amount.

4 - Select any image (if applicable to your system) to select the camera to adjust lighting.

5 - **Enable Normalization** - (or Disable Normalization). For most applications leave normalization disabled. If you are modifying an old part program that has normalization enabled, then leave it enabled.

Advanced Adjust Lighting

This screen provides additional lighting setup. This is mostly used by Pressco engineers, or for making infrequently performed specialized settings. Lighting must be adjusted while the lane is offline.

To get to this screen: Right-click over a sensor button | **Lighting** | **Advanced Adjust Lighting**.

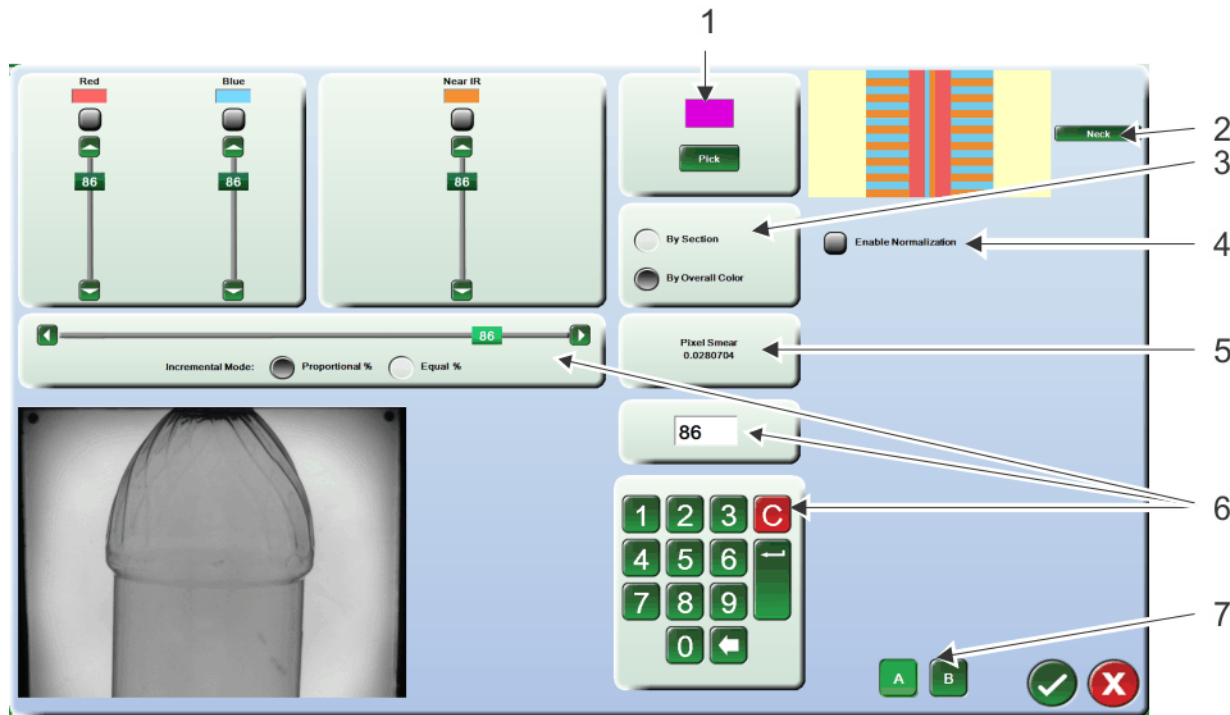

- 1) Opens a color palette and allows you to choose preselected colors.
- 2) If your inspection module has different lighting arrays, click one of the array buttons to adjust lighting by zone. [Advanced Adjust Lighting - Zones](#)
- 3) **By Section** - Change lighting by each section. **By Color** - Change lighting for multiple sections at once.
- 4) **Enable Normalization** - (or Disable Normalization). For most applications leave normalization disabled. If you are modifying an old part program that has normalization enabled, then leave it enabled.
- 5) **Pixel Smear** - The Intellispec computes the amount of pixel smear from lighting, image size, and part rate. It should be kept below one.
- 6) **On-screen keypad** - enter the percentage of color. This also moves the percentage slider.

7) **A/B buttons** - Set up two different lighting settings for the same part so you can compare.

This page left blank intentionally

Part Tracking

Sequence of Events During Inspection

This illustration shows a typical inspection sequence of events. Note that your system configuration may involve more components, and may be different than pictured here.

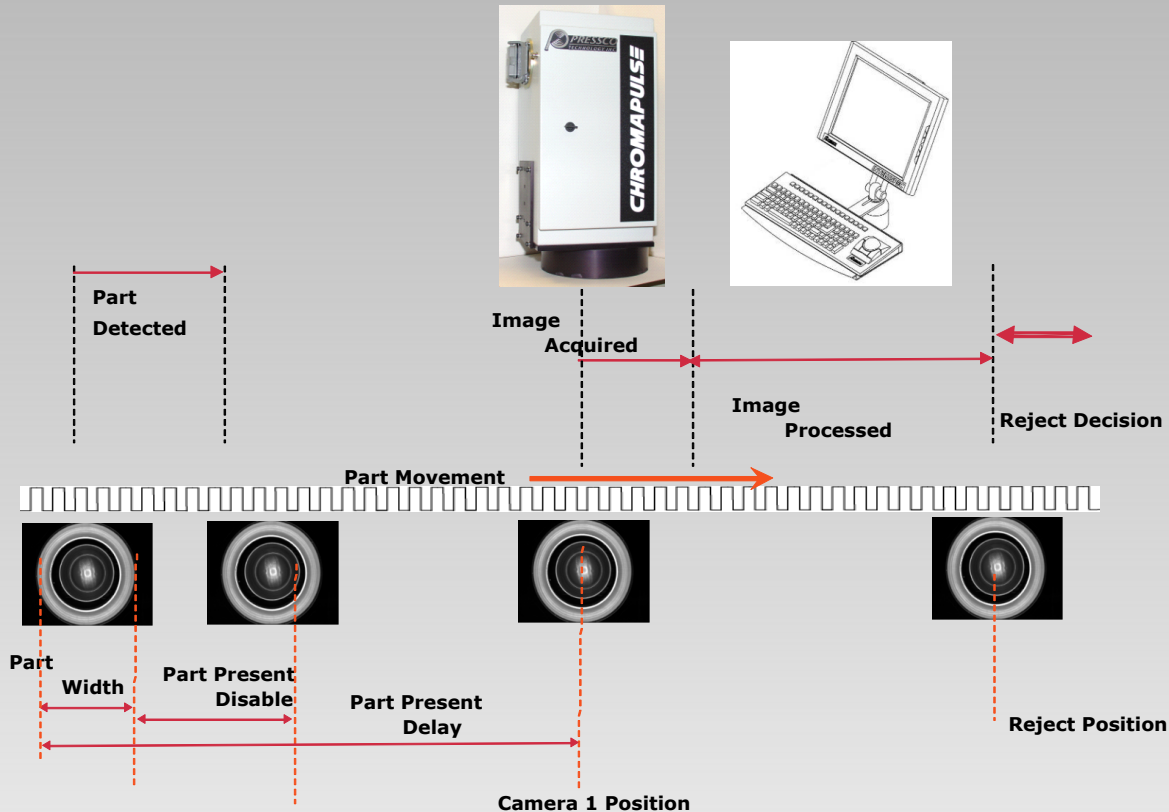

Part Tracking Terminology

Part Width The number of encoder ticks that the part sensor "sees" the part.

Part Present Delay The distance (in encoder ticks) from the part detect sensor to the camera centerline. If a PDX is used, this is the number of encoder ticks from the part detect pulse out of the PDX to the camera centerline.

Reject Time Delay The distance, in encoder ticks, from the part detect sensor (or from the PDX part detect pulse) to rejector. This signal

ensures the correct part is rejected.

Reject Dwell or Reject Pulse Width The duration (in milliseconds) of the reject signal. This signal must be long enough to ensure the part is efficiently rejected, and short enough to ensure that only one part is rejected for each reject pulse.

Adaptive Reject This feature is necessary when you have a significant change in product speed, since the rejector has a constant turn-on time. This logic allows the system to monitor the product speed and compensate the pulse being sent to the rejector.

Reject Confirm Not commonly used. This is the distance in encoder pulses from the reject mechanism to the reject confirm sensor (if installed).

Encoder



Encoder A device used to indicate mechanical motion with a pulse rate directly proportional to line/ conveyor speed. The system tracks part movement through encoder ticks, from the moment the part is detected until it passes the reject station.

Encoder/ PDX "Timing Wheel"

Encoder sensor counts pulses to know the position of the part



The encoder "Z" indicator is used to zero the count when the wheel has turned a full 360 degrees

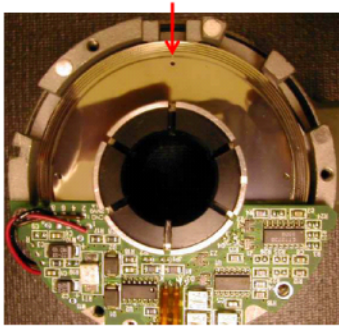

Part Tracking Using a PDX

The Part Detect Generator (PDX) is used in some applications where the Intellispec system inspects directly on a machine, rather than on a conveyor. The PDX is a circuit built into the Part Tracker board.

If a PDX is used, part tracking is done by:

- Monitoring the movement of the transfer wheel (or other machine component) with the encoder
- Feeding the signal to the software

- Programming the software with the resolution of the encoder and the number of pockets used
 - This generates a part detect pulse for every pocket
 - This part signal is used to acquire part images and generate reject pulses

An **empty pocket** inspection must be applied if using a PDX. The PDX tracks pockets, not parts, so the empty pocket inspection determines whether the part is in the pocket.

Advantages of using a PDX:

- No part detect sensor is used and therefore no component can be accidentally moved by a machine crash or during maintenance
- Part timing should not be affected when running different parts

Part Width Calibration

Part Width is the number of encoder ticks that the part detect sensor "sees" the part. To perform the calibration you must be running parts past the part detect sensor.

For systems using a PDX, the Part Width Calibration is not used, but values of 0 and 1 should be used respectively for Part Width and Part Present Disable Time.

Part-Width Calibration

In Use New Value

Part Width 0 (Encoder Ticks)

Part-Present Disable Time 0 (Encoder Ticks)

Calibration Results (Part Width)

Parts	Avg.	σ	Min	Max
127	71.46	14.89	45	94





Simulation

Confirm changes

 Do you want to apply the following changes to the system?

Part width changes from 0 to 72 encoderticks.
Part present disable time changes from 0 to 3 encoderticks.

To calibrate the Part Width:

1. From Sensor Overview mode, right-click a sensor button | **Part Tracking** | **Part Width Calibration**.
2. With parts running under the camera or sensor, select **Start Calibration**. As each part goes by its width is displayed in Part Width field.
3. After a sufficient number of parts have gone by (we recommend about 10 parts), select **Stop Calibration** (same button as Start Calibration). This will display the calibration results in the lower part of the screen.
4. Examine the results; look for the **minimum** and **maximum** values to be within approximately 10 encoder ticks of each other. If the results are acceptable select OK  to save the data. If the results are skewed, recalibrate the part width. To exit without saving the changes, select the exit  button.
5. The system will prompt you to confirm your changes. If the results are acceptable select OK  to save the data. If the results are skewed, select the cancel  button and recalibrate.

Part Present Delay Calibration

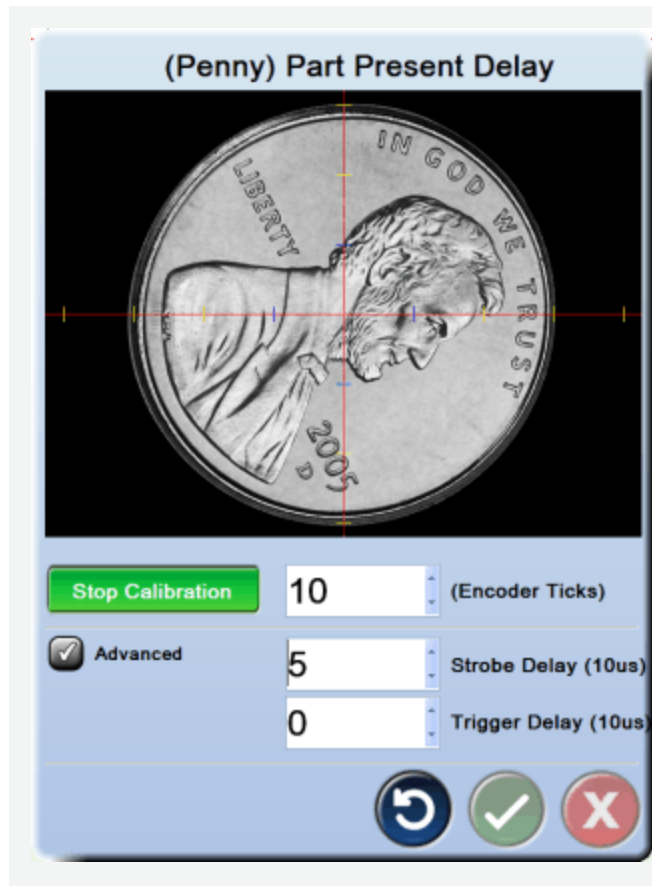

To calibrate the Part Present Delay:

1. From Sensor Overview mode, right-click a sensor button | **Part Tracking** | **Part Present Delay Calibration**.
2. Select the **Start Calibration** button.
3. Place a part onto the conveyor or into the part stream. The part will trigger the part detect sensor, then the system will count the number of encoder ticks and take a picture.
4. Manually adjust the part present delay (encoder ticks) value until the image is centered every time a part is run through the system.
5. When completed, select the **Stop Calibration** button. The Part Present Delay calibration value is saved and stored in a Lane configuration file.
6. Select the OK button to save changes and exit.

Reject Delay and Dwell Calibration

Calibrating Reject Delay and Dwell takes time and patience. In preparation, gather several different preforms if available, and/or use a marker to create 'defects' on preforms. Use as many preforms as it takes to complete proper calibration.

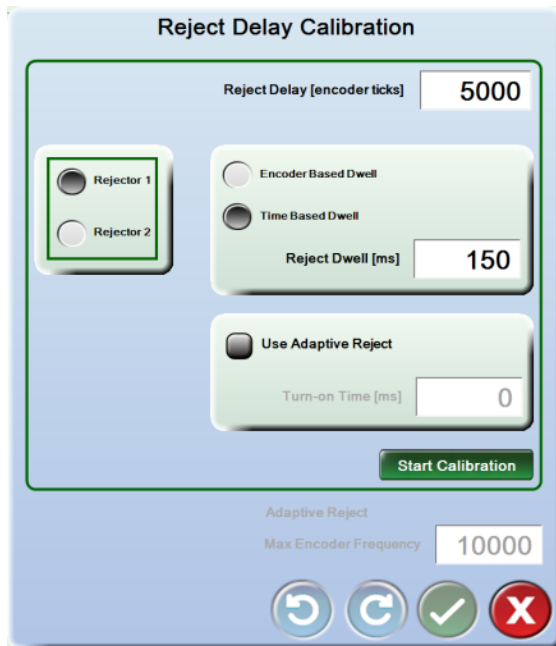

To calibrate the Reject Delay:

1. From Sensor Overview mode, right-click a sensor button | **Rejecting** | **Reject Delay Calibration**.
2. Select the **Start Calibration** button.
3. Place a part on the running conveyor or into the part stream. After the number of encoder ticks shown in the Reject Delay box, the rejector will be activated.
4. Make sure the correct part was rejected.
5. Continue to insert parts into the part stream.
6. Manually adjust the reject delay (encoder ticks) until the correct part is rejected every time.
7. Adjust **Reject Dwell** so that it is long enough to completely reject the part, and short enough that only one part is rejected for each reject pulse.
8. When completed, select the **Stop Calibration** button. The Reject values are saved and stored in a Lane configuration file.
9. Select the OK button to save changes and exit.

Adaptive Reject Calibration (optional)

Note: Adaptive Reject is not used in BNS



To calibrate Adaptive Reject:

1. Run the conveyor at maximum speed for about 35-40 seconds. This programs the adaptive reject logic for maximum product speed.
2. Go to the **I/O Diagnostics** screen and record the encoder rate while the line is running at max speed.
3. Go to the Reject Delay Calibration menu: Right-click over a sensor button | **Part Tracking** | **Reject Delay Calibration**.
4. Select the check box: **Use Adaptive Reject**.
5. Set the **Max Encoder Frequency** to the value you recorded in step 1.
6. Set the reject device **Turn On Time** (usually about 10 ms for air rejectors and about 15 ms for the pusher rejector).
7.  Select the OK button to save changes and exit.

Reject Confirm Calibration (optional)

Reject Confirm Calibration

Reject Confirm Delay [ms]

Rejector 1 Enable Confirm Time Based

Rejector 2 Enable Confirm Time Based

Gate Size 1 milliseconds Sensor Noise Filter 1 milliseconds

Gate Size 2 milliseconds Sensor Noise Filter 2 milliseconds

Jam Detection Timeout ms

To calibrate Reject Confirm:

1. From Sensor Overview mode, right-click a sensor button | **Rejecting** | **Reject Confirm Calibration**.
2. Check **Enable Confirm**.
3. If using time-based Reject Confirm, then also check the **Time-Based** box, and set **Gate Size**, **Sensor Filter** and **Jam Detection Timeout**.
4. Select the **Start Calibration** button.
5. Run a part through the system. Tip: for best results, run about 10 parts through the system.
6. When completed, select the **Stop Calibration** button. The system will compute Reject Confirm Delay. [Reject Confirm Delay = (number of pulses from Part Detect to Reject Confirm Sensor) minus Reject Delay]
7. Select the OK button to save changes and exit.

The following parameters are used only with **Time-Based Reject Confirm**:

Gate Size The time interval (in milliseconds) that the system looks for the product to pass by the reject confirm sensor. The valid range is 1 to 63 milliseconds.

Sensor Noise Filter The shortest pulse width (in milliseconds) that the reject confirm sensor will pass. This is used to filter out glitches or noise. This is usually set much smaller than part width, but larger than glitches or noise. The valid range is 0 to 4 milliseconds.

Jam Detection Timeout Specifies how long the sensor is blocked before the **Jam at Reject Confirm** alarm is triggered. This alarm must be enabled through Lane Alarm Configuration. The valid range is 1 to 32000 milliseconds.

PDX Configuration

The Part Detect Generator (PDX) is used in some applications where the Intellispec system inspects directly on a machine, rather than on a conveyor. The PDX is a circuit built into the Part Tracker board.

Note: the system cannot run in both PDX mode and Part Tracker Simulation mode at the same time. If one mode is already running and you enable the other mode, the system displays a warning that the latest setting will override the previous mode.

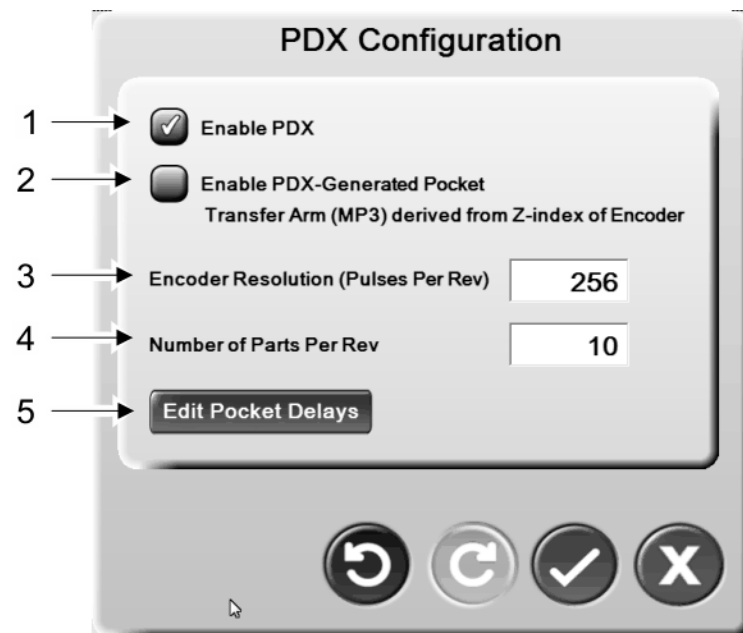

To get to this screen: From Lane or Sensor Overview mode, select Tools  | **Hardware Setup** | **PDX Configuration**.

To configure the PDX:

1. Select the Enable PDX check box.
2. Enter the encoder resolution used on your system (example, 8192 pulses per revolution).
3. If your system is NOT using a pocket disk to generate the index signal, check the Enable PDX-Generated Pocket box.
4. Select the OK button to accept changes and exit.

1 - **Enable PDX** Enables the PDX circuit.

2 - **Enable PDX-Generated Pocket** On **Most systems** - If your system is not using a pocket disk, and you need the Z-index signal of the encoder, check this box. This eliminates the need for a pocket disk. The index signal is handled on the Part Tracker board. Or, if your system is using a physical pocket disk with an index pin, leave this box un-checked.

3 - **Encoder Resolution (Pulses Per Rev)** Enter the resolution of the encoder installed on your machine.

4 - **Number of Parts Per Revolution** Enter the number of machine parts or pockets (example, number of Transfer Arms) where the encoder is attached.

5 - Edit Pocket Delays

This feature only needs to be used if machine parts become unevenly spaced. If your system has rigid machine parts and consistent spacing part to part, then no further action is needed.

For this explanation, Encoder Resolution [3] = 256. Number of Parts Per Rev [4] = 10.

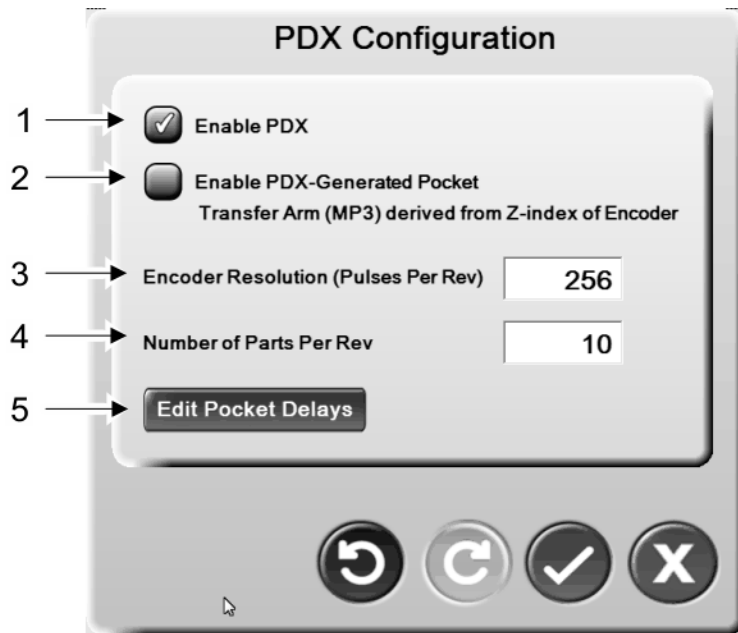

When you click the Edit Pocket Delays button, you can manually change the delays, as shown below.

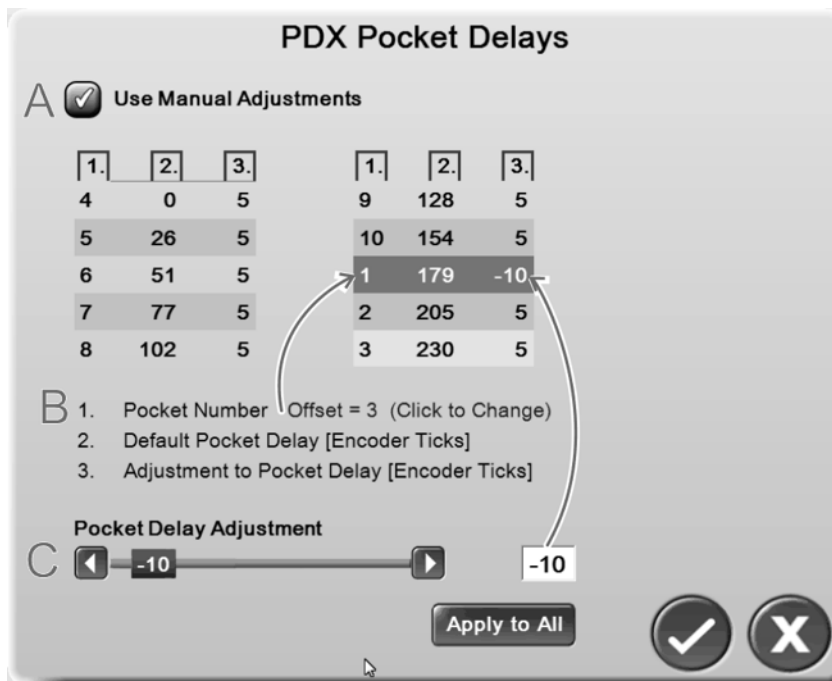

A - ✓ = enabled

B - **Pocket Number [Column 1]** - If you have a pocket (physically) marked as pocket #1, but the index pulse is 3 pockets away, you can use 3 as an offset (as shown in the above example). If the index pulse is located at pocket #1, then no offset is necessary.

Default Pocket Delay [Column 2]- This is computed for you. The system divides Encoder Resolution [3] by the Number of Part Per Rev (pockets) [4], and computes the delay between each pocket.

C - Pocket Delay Adjustment [Column 3] - You can change the delay for one pocket, or **Apply to All**. If just one machine part has shifted, then you may only need to change the delay for one pocket.

You may notice that sometimes you can enter a negative number, and sometimes not, or a value for the last pocket is limited more than others. Pocket delays are sent as a list of values to the part tracker. The system computes valid values for the part tracker rules, which include: non-negative values, subsequent delays are larger than the previous delays, and the last delay must be fewer ticks than the encoder resolution.

Part Width Calibration using PDX

see [Part Width Calibration](#)

Note: For systems using a PDX, the Part Width Calibration is not used, but values of 0 and 1 should be used respectively for Part Width and Part Present Disable Time.

System Maintenance and Troubleshooting

Maintenance Frequency with Chromapulse Modules

Item	Description	Frequency
Observe proper rejection	Verify that defective parts are being rejected by inserting a known defective part through inspection	Daily
Observe Proper inspection	Verify that no stray parts are stuck in or near the inspection module or reject station	Daily
Observe Proper inspection	Verify that no buildup of dirt or contaminants has occurred on inspection module. Clean if necessary.	Daily
Observe Proper inspection	Verify that each camera's image is properly centered, focused, and properly lit. Adjust if necessary.	Daily
Support Package	Create a snapshot of your Intellispec settings.	Monthly
Acronis Backup	Create a full System Backup.	Yearly
Clean Vision Processor Filter	Rinse in clean water; use mild soap and water solution if oily.	Monthly
Glass surfaces	Clean with soft, clean, oil-free cloth dampened with glass cleaning solution	Daily
Plastic surfaces	Clean with soft, clean, oil-free cloth dampened with mild soap and water solution	Daily
Part Detect Sensor and Reflector	Clean with soft, clean, oil-free cloth dampened with mild soap and water solution. Wipe dry.	Weekly
Camera lens	Clean only with lens tissue and lens cleaner. Be careful not to alter focus or aperture.	Monthly
Glass surfaces: Beam Splitter and Secondary lens	Clean with soft, clean, oil-free cloth dampened with lens cleaning solution	Monthly
Ellipsoidal mirror	Normally does not need cleaning. If dirty, blow off dust with clean, compressed air.	Only if dirt appears on image
Plastic surfaces: Dome light or Ring light diffusers	Clean with soft, clean, oil-free cloth dampened with mild soap and water solution. Wipe dry.	Monthly
Fan filters CP4422EV	Rinse in clean water; use mild soap and water solution if oily.	Monthly
Filter/ Regulator	Replace filters	Oil removal filter - replace every

Item	Description	Frequency
		2000 hours Oil vapor removal filter - replace every 12 months

Cleaning the Vision Processor Filter

The filter for the vision processor should be cleaned once a month for best results. The filter is located underneath the user interface cabinet. If the filter has holes or is too dirty to clean, then replace it with Pressco part number 66621.

Note: You may need to clean the filters weekly depending on plant conditions

To clean the filter:

1. Pull down the front of the grate [item 1] with your fingers.
2. Remove the filter [item 2] and clean it.

If the filter contains dry dust and dirt, rinse it in plain water

If the filter contains oily dust and dirt, clean it in soapy water, then rinse in clear water

1. Dry the filter completely, then place it back underneath the user interface cabinet.
2. Push the grate closed.

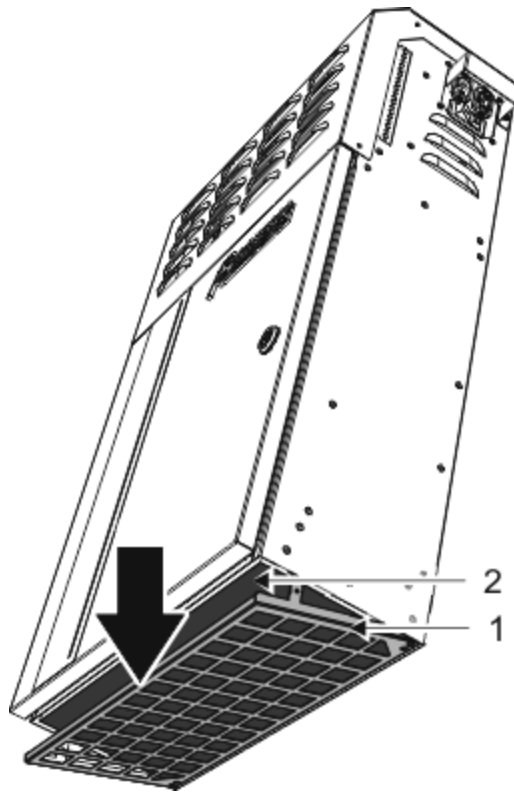

1) Grate to hold filter in place

2) Part number 66621 - filter for vision processor

Cleaning the Part Detector and Reflector

The part detect sensor and reflector surfaces of the part detector must remain clean to properly detect parts. Clean these surfaces regularly to prevent dirt and oil build-up.

Clean the part detector surfaces with a soft, clean, lint-free cloth dampened with a mild soap and water solution. Do not use a glass cleaning solution or strong solvent on the plastic surfaces as they might be damaged.

The frequency of cleaning will depend on plant and process conditions.

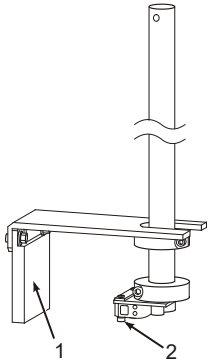

1) Part detect reflector

2) Part detect sensor

Cleaning the Camera Lens



Caution: Do not touch the lens with fingers or oily cloths.

To clean the camera lens:

1. Raise the camera to access the lens by loosening the height adjustment screw [item 1].
2. Leave the clamping bracket in place [item 2].
3. Clean all camera lenses with lens tissue and lens cleaning fluid. Be careful not to alter the focus or aperture of the cameras.
4. Slide the camera back into position as marked by the clamping bracket.
5. Tighten the height adjustment screw
6. Re-adjust aperture and focus if needed.

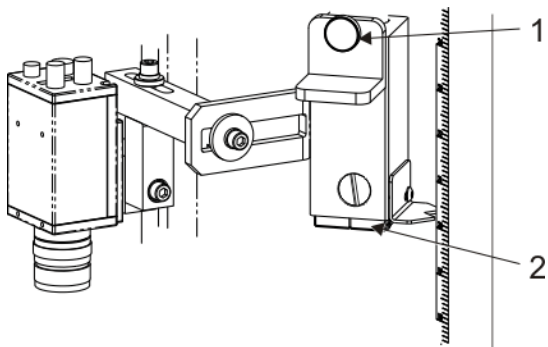

- 1) Camera height adjustment screw
- 2) Clamping bracket - camera height reference

Cleaning the Chromapulse Beam Splitter

You must remove the Beam Splitter (on some Chromapulse models) to access the bottom side for cleaning. The method for removing the beam splitter depends on your inspection module.

In the illustration below, item A is used in preform sidewall endcap (PSE) modules. Item B is used in seal surface modules and some Chromapulse modules (example: CP750EV, CP1200EV, and more).

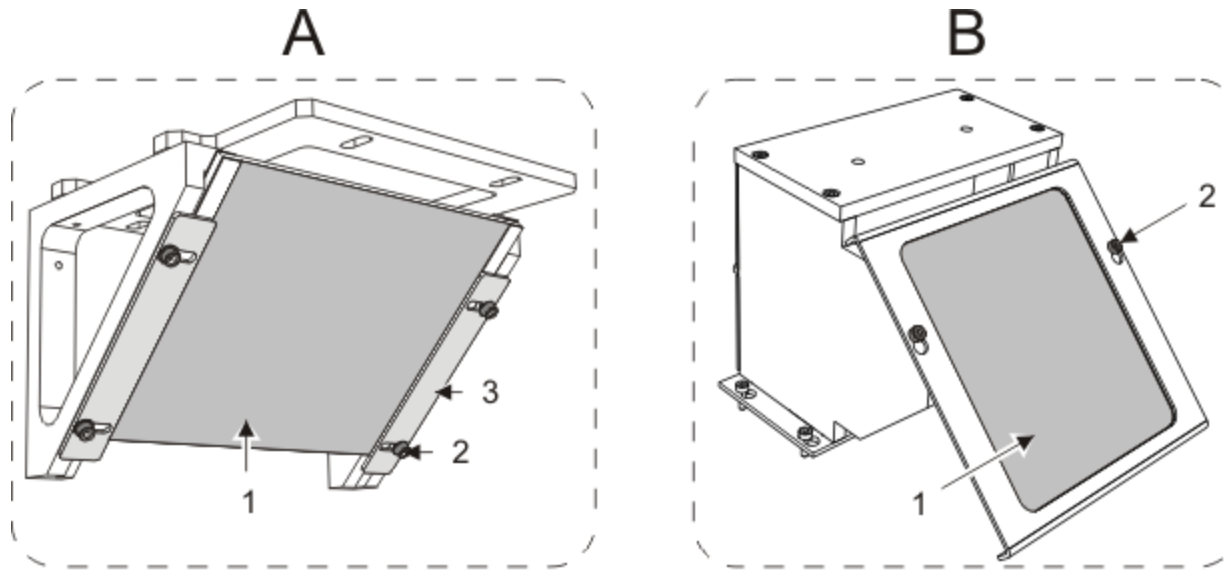

- 1) Beam Splitter
- 2) Screws
- 3) Retaining plates

To clean beam splitter:

1. Raise the camera if necessary. Be sure to note the camera position before moving it.
2. Loosen the screws [item 2] and carefully remove the beam splitter.
 - Item A has four screws. Slide the retaining plates [item 3] to the sides and remove the beam splitter.
 - Item B has two screws. Loosen the screws to remove the beam splitter.

3. Clean the beam splitter [item 1].
 - Blow off dust from beam splitter with canned, compressed air.
 - Clean the glass on the beam splitter using lens tissue and lens cleaner.
4. Replace the beam splitter assembly.
 - Item A - Replace the beam splitter with the reflective side to the outside. Slide the retaining plates back in plates and tighten the screws.
 - Item B - Replace the beam splitter with glass to the inside. Tighten the screws.

Cleaning the Ellipsoidal Mirror

This mirror provides the enhanced neck image for optimal inspection of the neck of a can.



Warning - The special surface of the mirror can be easily scratched. Take special precautions and do not touch the surface of the mirror.

Note: This mirror does not require periodic cleaning. Contact Pressco Service if the mirror has dirt or marks that cannot be blown off with clean, compressed air.

In most systems, the mirror has a built-in air cleaning system. Air is blown through the module to keep dust and debris off the mirror and out of the module. There are no bottom shields on these modules. You do not have to clean the mirror in these modules.

Cleaning or Replacing the Chromapulse Fan Filters

Replace the filters once a month, using part number 66446.

If you do not have replacement filters, clean them once per month. Remove the covers to access the filters.

- If the filter contains only dry dust and dirt, rinse it in plain water
- If it contains oily dust and dirt, clean it in soapy water
- Dry the filter completely before reinstalling it

To replace a filter, use: Part number - 66446: Replacement filter element (same part number is used in both locations)

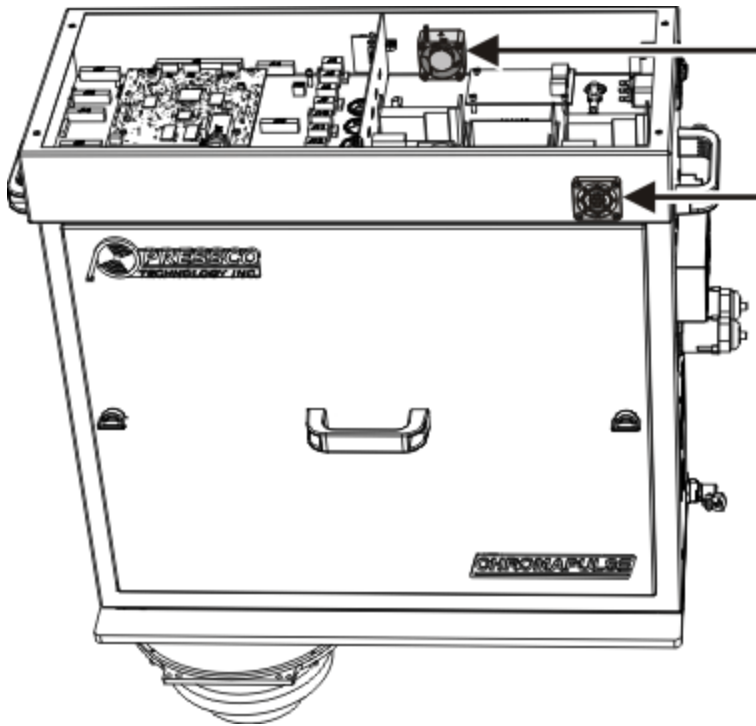

Replacing Filter-Regulator filters

The filter/ regulator assembly shown below is installed with CP4422EV inspection modules. Replace filters.

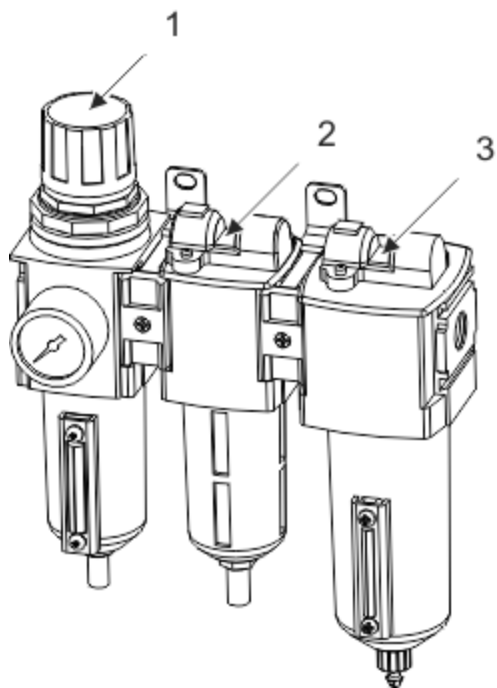

	Pressco part number	Description	Replace at least:
1		Filter/ regulator. No filter change necessary.	
2	67620	Filter oil removal	Every 2000 hours
3	67621	Filter oil vapor removal	Once per year
	67622	Kit (contains one each of 67620 and 67621) It is easier to replace both of these filters at the same time	

Troubleshooting Tools and Information

Camera LED Indicators

Digital Camera LED Status



STATUS LED

- Solid IP Address Assigned
- Slow Waiting for an IP Address
- Fast Ethernet Cable Disconnected
- Solid Application Linked to the Camera
- Slow Trigger Acquisition in Progress
- Fast Acquisition in Progress
- Slow Camera Initialization Problem
- Fast Camera Overheating

LED Status	Definition	
LED OFF	No power / No trigger pulse	
GREEN	Steady*	Application connected
	Slow Flashing	Triggered acquisition in progress
	Fast Flashing	Free running acquisition in progress
BLUE	Steady	IP assigned but no application connected
	Slow Flashing	Waiting for an IP Address
	Fast Flashing	Ethernet cable disconnected
RED	Steady	Camera not initialized
	Slow Flashing	Camera initialization problem
	Fast Flashing	Camera is too HOT

Link LED

Orange	1 Gb
Green	100Mb

NOTE: Always be Orange when connected to an IntelliSpec

Traffic LED

Yellow	Traffic
--------	---------

Normal Camera Connection LED Progression

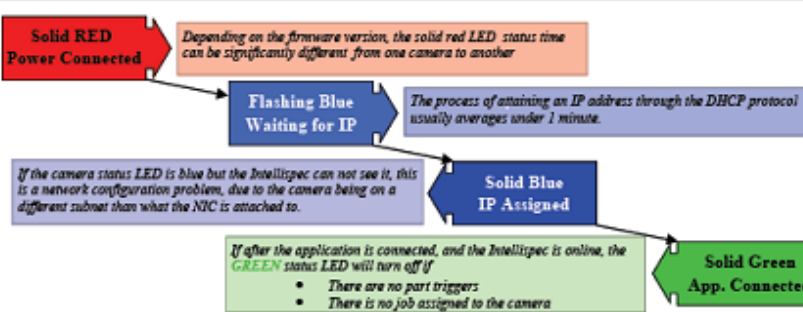

Solid RED Power Connected → **Flashing Blue Waiting for IP** → **Solid Blue IP Assigned** → **Solid Green App. Connected**

Depending on the firmware version, the solid red LED status time can be significantly different from one camera to another

The process of attaining an IP address through the DHCP protocol usually averages under 1 minute.

If the camera status LED is blue but the IntelliSpec can not see it, this is a network configuration problem, due to the camera being on a different subnet than what the NIC is attached to.

If after the application is connected, and the IntelliSpec is online, the GREEN status LED will turn off if

- There are no part triggers
- There is no job assigned to the camera

Normal On-Line Camera LED Status



Status LED Flashing Green when acquiring images

Link LED Solid Orange

Traffic LED Flashing Yellow

NOTE: Depending on amount of traffic, the LED can be flashing as quickly it may appear to be solid yellow

***NOTE:** If a camera is connected while the application is running the status LED may turn green but it might not acquire images. To avoid this, always power down the IntelliSpec when connecting a camera.

Help - Remote Support

Remote Support allows remote access to the Intellispec software. iTivity software is used by Pressco to provide remote system support if a **Maintenance Agreement** is purchased for that Intellispec system.

You will need:

- A functioning Intellispec (systems without power, or systems that are not capable of running Intellispec software, cannot be remotely accessed)
- An internet connection to your Intellispec. This can be established through your network, and is usually set up during installation. You may use DSL, Cable, Mobile Broadband, or plant network connections to connect to the internet. Contact your network administrator for help.

To use Remote Support:

1. Notify a Technical Support representative that you require remote support. You will need to identify yourself, your location, and the Intellispec to which he should connect.
2. In the Intellispec software, Select Help  | **Remote Support**.

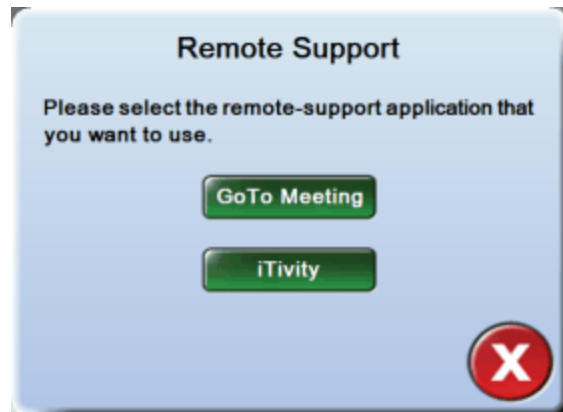

3. Select the **iTivity** button. If your system has a valid internet connection, the iTivity agent will attach to the server at Pressco. A connection status screen will appear indicating that the session has been established, as shown below. Intellispec systems are identified by computer name, which, in most cases, is the serial number.

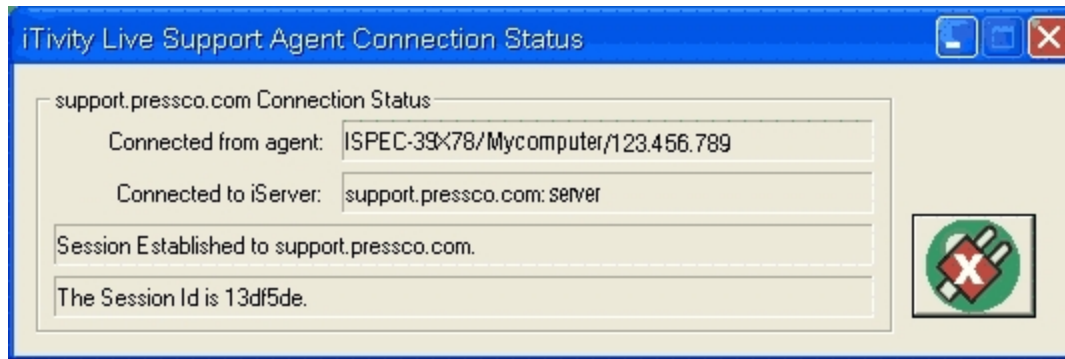

4. When the Pressco Tech Support representative is connected, you will be asked to give him control of your Intellispec system. Check Allow remote user MOUSE and KEYBOARD control and select Accept. The Tech Support representative will now perform the necessary troubleshooting of your system.

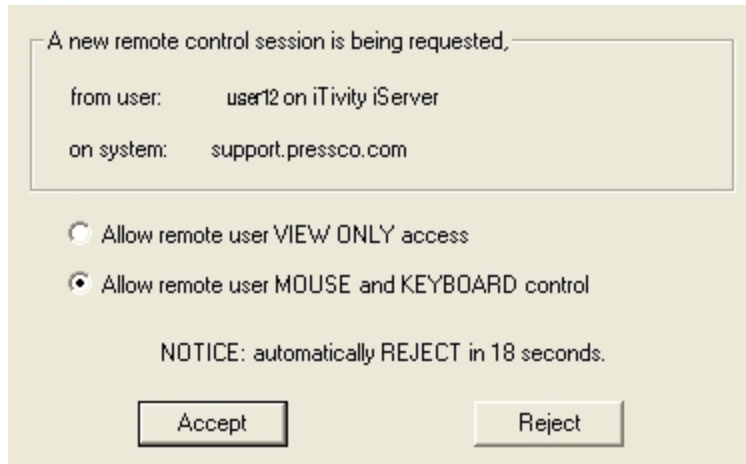

5. When the Tech Support representative is finished, he will disconnect your Intellispec from the remote session.

If you need to disconnect your Intellispec from the remote session yourself, follow the steps below.

To disconnect from remote support:

1. Select the X in the upper right corner of the 'iTivity Live Support Agent Connection Status' box.
2. When the system asks "Do you really wish to exit the iTivity Live Support Agent?" select OK. The system will be disconnected.



Note: if you select the button, the session will be disconnected, but this does not close the remote support program.



If the session is disconnected and you want to allow Tech Support to be able to access your system again, select the button.

support.pressco.com Connection Status



Agent disconnected:	ISPEC-39X78/Mycomputer/123.456.789
Disconnected from iServer:	support.pressco.com: server
Not Connected.	
The Session Id is 1ab1b77.	





Exiting the Intellispec software

You must have proper user permissions to exit the software. This prevents unauthorized system shutdowns. Contact your system administrator if you need user permissions.

To exit Intellispec software:

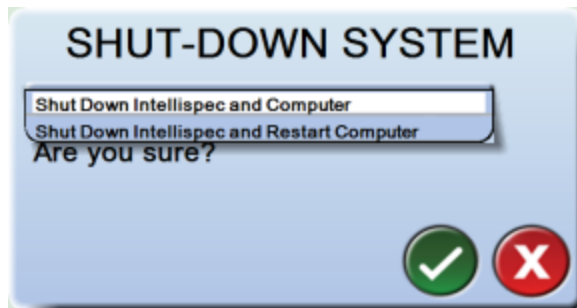
1. Log in.
2. Select Home  | Tools  | **Exit System**.
3. Select an option.



4. Select the OK  button. The Intellispec software and/or computer shuts down (and restarts if applicable).

Discovery Software - What is Discovery?

Discovery is software installed on the Intellispec hard drive that automatically looks for and identifies certain components installed on each lane. The software identifies sensors, cameras, lighting drivers, part trackers, and if used, Intellimass drivers that are attached to the system. Each one of these devices communicates with the Intellispec software via Cat -6 cabling and is assigned a unique MAC address.

You should rarely need to use this software. However, if a new component (for example, camera) is installed on the system the software would be used to configure the new camera.

Additionally, during system startup, if a previously configured component fails to communicate with the Intellispec software, the discovery software screen will automatically appear on the user interface, alerting you to the problem.

Discovery software screen



- 1) The Discovery menu toolbar allows you to perform additional actions.
- 2) The tree shows the system configuration. **Red** indicates unassigned hardware devices. Orange indicates missing hardware devices.
- 3) Select one of the buttons to perform specific actions, such as add or edit lanes or sensors.

Discovery Menu Toolbar



Tools Menu

- **Rediscover New Hardware** - when this command is initiated this software will perform another search of all hardware communicating with the Intellispec and displayed in the tree on the left side of the screen.
- **Add Simulated Devices for Testing** - this is software used by Pressco engineers to assign devices on an Intellitainer.*
- **Inspection Module Preset Editor** - this is software used by Pressco engineers to assign new components as they become available.

 **Wizard Menu** - the same choices as those listed in the green buttons in the center of the screen.

 **Language Menu** - displays language choices that can be displayed.

 **Help** - provides software and systems for users.

*Intellitainer = portable Intellispec training computer.

Part Programming

Part Changeover

When changing parts to inspect, you only need to change the part program (if you have a part program already set up for the newly inspected part type).

This will load the proper inspections, lighting, and guide rail settings, if applicable (as long as these were previously set).

Some menu items are only available to advanced level users.

What you need:

User permission to Switch Part Program

To change parts:

1. Log in.
2. Click the part drop-down menu.

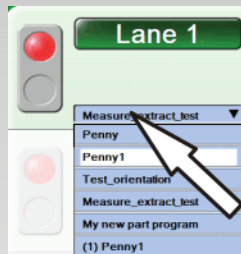

3. Click the name of the new part to inspect. The new part program is loaded on the Intellispec.
4. Put the lane online to begin inspecting new parts.

Lane-specific information is contained in each Part Program. Everything you set up have previously set up is stored: camera information, lighting information, calibration information, and inspections.

Manage Part Programs

Create new part programs or delete, edit, rename, import or export existing part programs for all the different products inspected with the system.

To **load** a part program, see [Part Changeover](#)

To get to this screen:

- From Lane or Sensor Overview mode, select Tools  | Lane Setup | Manage Part Programs. Or:
- Right-click the Part Program drop-down menu.



Edit Part Notes Add setup and program information about the part. This is helpful if you need to modify the part program later. These notes are displayed at the bottom of the Manage Part Programs screen when you select or change a part program.

Create, Copy, or Import a Part Program

You will need:

System permissions to create part programs

To create a Part Program:

1. Go to a Lane Overview or Sensor Overview screen.
2. Right-click over the part program drop-down menu. Choose from the available options.

The image shows a control panel interface. On the left, a panel titled "Lane 1" displays statistics: "Total Parts" (0), "Defects" (0), and "Defect %" (0.000). Below these is a dropdown menu currently showing "Penny". To the right, a larger window titled "Manage Part Programs" contains a list of "Part Programs": "Master Rec Food Can", "(1) Master Rec Food Can", and "Purple part". A vertical toolbar on the right side of this window includes buttons for "New", "Copy", "Rename", "Load", "Delete", "Import/Export", "Edit Part Notes", and "Remote Switching". At the bottom of the "Manage Part Programs" window, it states "Currently Running Part Program 'Purple part'" and shows "Notes for '(1) Master Rec Food Can': increased ambient 12.23.14". A checkmark icon is visible in the bottom right corner of the window.

Right-click

Inspection Overview

Inspection Terminology

Analysis Analyzes the pixel shade information within a region and compares it to reference values. The inspection passes or fails based on these comparisons. There are also several analyses that make measurements. You may have many analyses for each inspection region.

Dimension The dimension inspection type connects the results of two other inspections to do the analysis. For example, a distance inspection can connect two registrations to measure the distance between centers of two features.

Enhancements Enhancements are used to alter images for better defect detection, or for making certain features stand out.

Inspection Module The housing, camera, cables, and associated electronics that are installed on or over the production line to acquire an image of your product. Sometimes referred to as a tunnel. The inspection module can have a different sensor than a camera to make measurements of your product (example: Intellimass sensor).

Lane A lane usually refers to one production line, and can contain multiple sensors.

Orientation An orientation compensates for part rotation by finding a grayscale pattern. An analysis which must rotate with the part must follow an orientation.

Part Program The list of regions, analyses, registrations, etc. programmed specifically for your part to detect defects or make measurements.

Part Tracking refers to the monitoring of parts from the part detect sensor to reject station. This ensures that the correct parts are rejected at the correct time, and that good parts remain in the part stream.

Region The Region indicates where on the part the analyses will take place. You may have as many inspections as you like in one region.

Registration A registration compensates for part movement by finding the reference point on the part. All analyses follow a registration.

Reject A part that failed one or more inspections from any sensor. The part can be physically rejected, or simply counted in the statistics.

Retro-Spec The graphical interface that allows you to make quick changes to a part program. It also allows you to experiment with different parameter settings to see how changes affect the most recent inspection population, without rejecting parts.

Sensor A camera, Intellimass, or other sensor that acquires images, measurements, or other data from your product.

Icon or Symbol Options (Sensor Menu)

Icons or symbols indicate the General Type of inspection for each item. ✓ = enabled

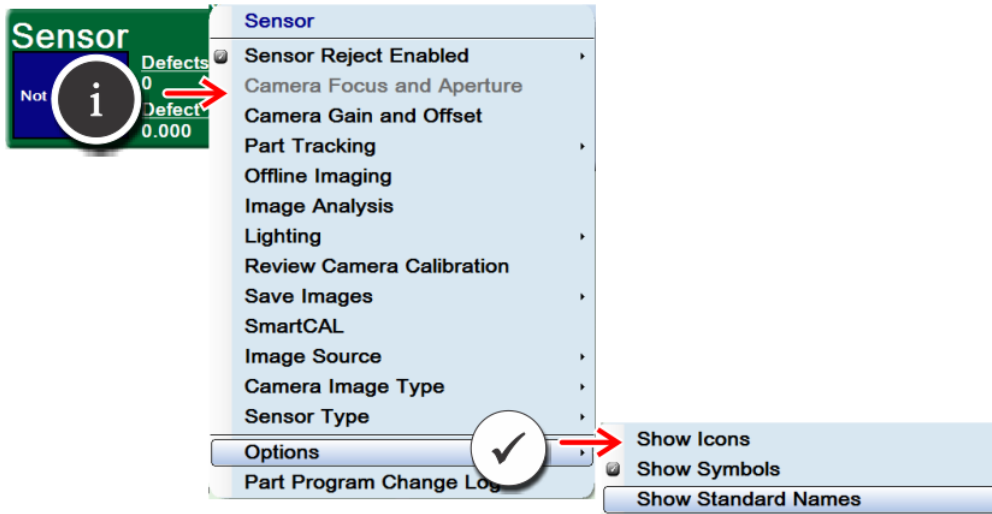



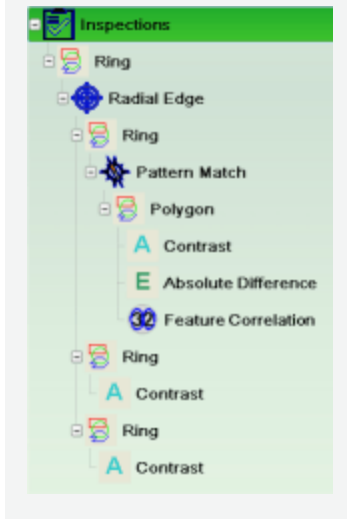











Show Icons



Show Symbols



Icon	Symbol	General Inspection Type
		Region - location of inspection
		Registration - to find part center or point of reference
		Analysis - inspection
		Correlation - inspection to correlate a part to the machine part where it was made
		Orientation - to place an inspection on the same location on each part, regardless of part rotation
		Enhancement - to add image processing to make defects or part features stand out better
		Intellispec Mass inspection

Inspection Tree Configuration

Inspection menu

Create and edit part programs through the inspection menu. To see this menu, right-click over any inspection name.

We use the term 'inspection' as a generic term for analyses, regions, enhancements, registrations, dimensions, etc. some items are grayed out if you do not have user access to those items, or if they do not apply to the current selection.

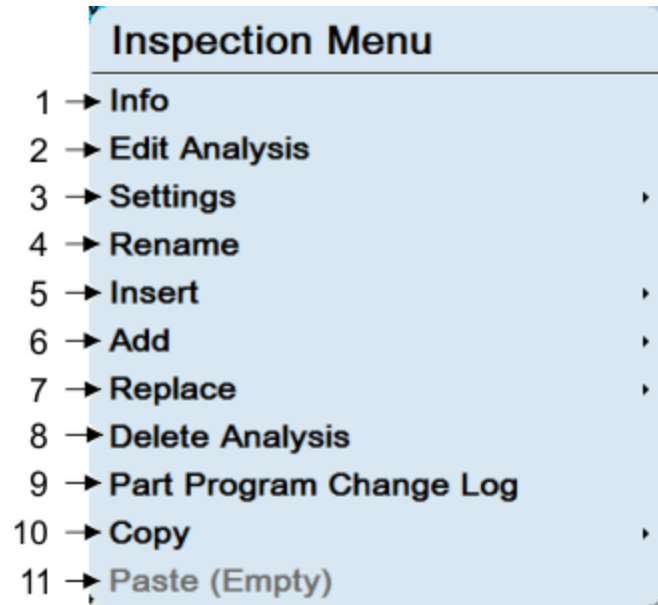

1 - Info

Display general information about the inspection. The **Specific Type** is the name used in the **Inspections** section in this guide



1 - **Name** - your name for the inspection | 2 - **General type** - Analysis, Region, Orientation, etc. | 3 - **Specific type** - sub-category (example, Ring, Polygon, or Measurement Region)

2 - **Edit** Open the Inspection Editor - performs the same action as double clicking.

3 -Settings

Inspection sub-menu. ✓= enabled

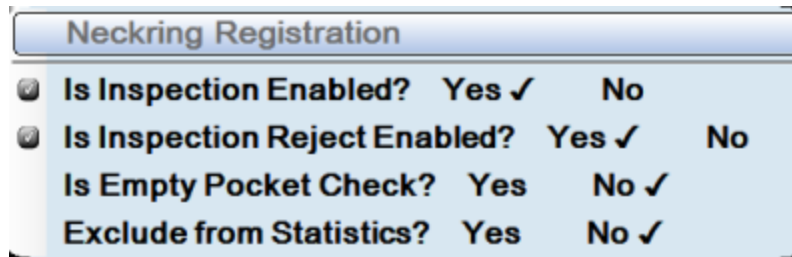

Is Inspection Enabled? All of its dependent inspections are also enabled/disabled. The inspection name is grayed out when it is disabled.

Is Inspection Reject Enabled? If "No" is checked, then you can temporarily pass all parts regardless of whether they pass or fail the current inspection. Some items, such as Regions, do not have pass/fail criteria. This option is grayed out if reject is not applicable.

Is Empty Pocket Check? If "Yes" is checked, then inspection is being used as an empty pocket check.

Exclude from Statistics? If "Yes" is checked, then do not count failures of this inspection in the statistics. If "Yes" is checked, then:

- The inspection is not displayed in graphs
 - If the inspection fails on a sensor, and no other inspection fails on the same sensor, the defect count is not increased for that sensor.
 - If the inspection fails for a walk-by group and no other inspection fails in the same group, the defect count is not increased for that group.
 - If the inspection fails and is the only inspection failing within a lane, the defect count is not increased for that lane.
 - The inspection is still displayed in the results grid when you select the **Reject Images** button.
-

- The inspection name is still available in the drop-down selections when you select the **SPC Graphs** button.
 - You can still view this inspection in the Inspections graph and Statistics Grid if you select the appropriate Display option (right-click over graph).
-

Start or Stop Auto-Learn (not shown) [Present when Operator Trigger is enabled in Auto-Learn] Manually start or stop an Auto-Learn process. See Auto-Learn.

4 - Rename the inspection

5 - **Insert** Add one item above the currently selected item.

6 - Add an inspection

7 - **Replace** Replace the current item with a similar inspection.

8 - **Delete** Delete the current item. If the item has other items below it (at a lower hierarchy), those items are deleted as well. Delete All Inspections deletes all the items in the inspection tree.

9 - **Part Program Change Log** Display the "Part Program Change Log" on page 169. This lists the inspections and the edit history for each.

10 - Copy the selected inspection

11 - **Paste** Paste the contents of the clipboard into the inspection list. The contents are pasted below the currently selected item.

Reject Enable/ Disable for Sensor Only

If the system is rejecting excessive parts, you can quickly disable the rejecter for that sensor.

To enable or disable the rejecter for one sensor only:

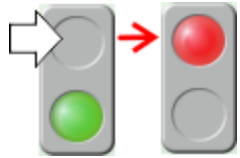

Take the lane offline.

From Sensor Overview mode | right-click over the sensor button | **Rejecting** | uncheck **Sensor Reject Enabled**.

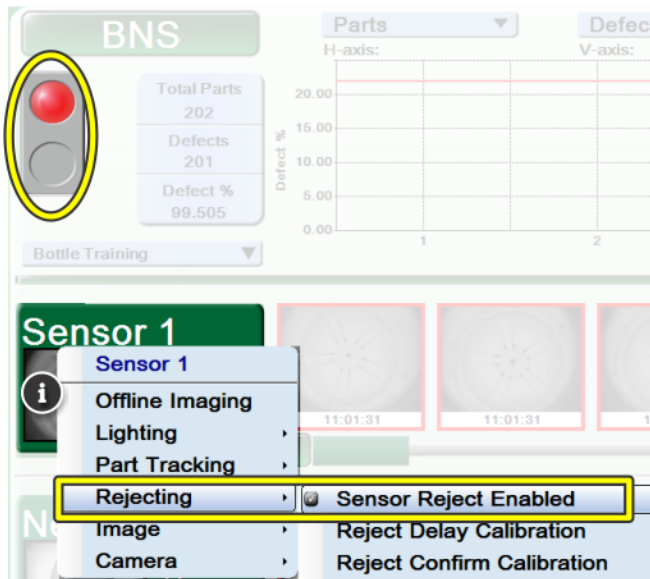

This toggles to **Sensor Reject Disabled**. Red text = disabled.

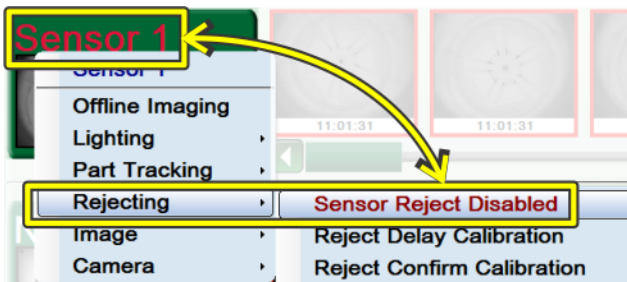

If you put the system online when the Sensor rejector is disabled, you will see a message stating "Sensor Rejector Disabled - Do you want to go online?" You may select Yes and continue online.

Reject Enable/ Disable for Multiple Sensors within a Lane

To enable or disable the rejector for one or more sensors within a lane:

1. From Lane Overview or Sensor Overview mode, select Tools  | Lane Setup | Rejecting | Rejector Enable/Disable.
2. Check or un-check the box next to the sensor(s) to enable or disable the rejector.



✔ Select the OK button to save changes and exit. The new setting is applied.

If a rejector is disabled, the sensor name is displayed in red instead of white.

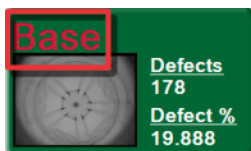

If the rejector for all sensors within the lane is disabled, you will see the trash can icon near the statistics for that lane.

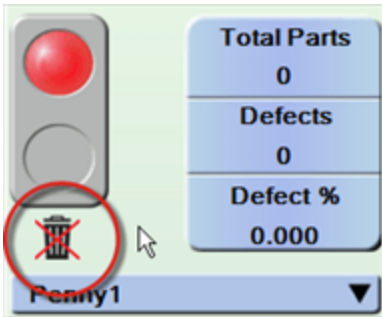

Note: the trash can symbol is only displayed if ALL sensors within the lane are disabled.

If you put the system online when the lane rejectors are disabled, you will see a message stating "Lane Rejector Disabled - Do you want to go online?" You may select Yes and continue online.

Edit Regions

This view is available when you are editing a **region**. Double-click a region name in the inspection tree to see the region editor. You must have user permissions to edit.

*In Region editor, you will not see anything happen if you select numbers 5, 6, or 7. The data set is changed, but you will not see the data set until you view the **Inspection Editor**.*

The screenshot displays the Region Editor interface. At the top, a horizontal strip shows a sequence of images, with the first one labeled '1'. Below this, a large image of a coin is shown with a green circular region of interest (ROI) around its edge, labeled '2'. A green rectangular box around the coin is labeled '3'. To the right of the coin image is a parameter table for the ROI:

Orientation ROI	
X	0
Y	0
Inner Radius	190
Thickness	11
Use Arcs	<input type="checkbox"/> Enabled

Below the parameter table is a section labeled '[Regions]'. At the bottom of the interface is a control bar with several icons and buttons, numbered 4 through 10. The icons include a left arrow, a '+100' button, a refresh button, a 'Snap' button, a right arrow, a parameter description window, and a set of three buttons (Undo, Redo, Accept/Cancel).

- 1 - Unwrapped region of interest (ROI)
- 2 - Part image
- 3 - Editable region
- 4 - Previous and Next image
- 5 - Get 100 new images
- 6 - Refresh data set
- 7 - Snap one image
- 8 - Edit parameters
- 9 - Parameter description window
- 10 - Undo/ Redo/ Accept/ Cancel

Edit Inspections

Edit an inspection. You must have user permissions to edit.

The Retro-Spec graph at the top of the screen is described separately.

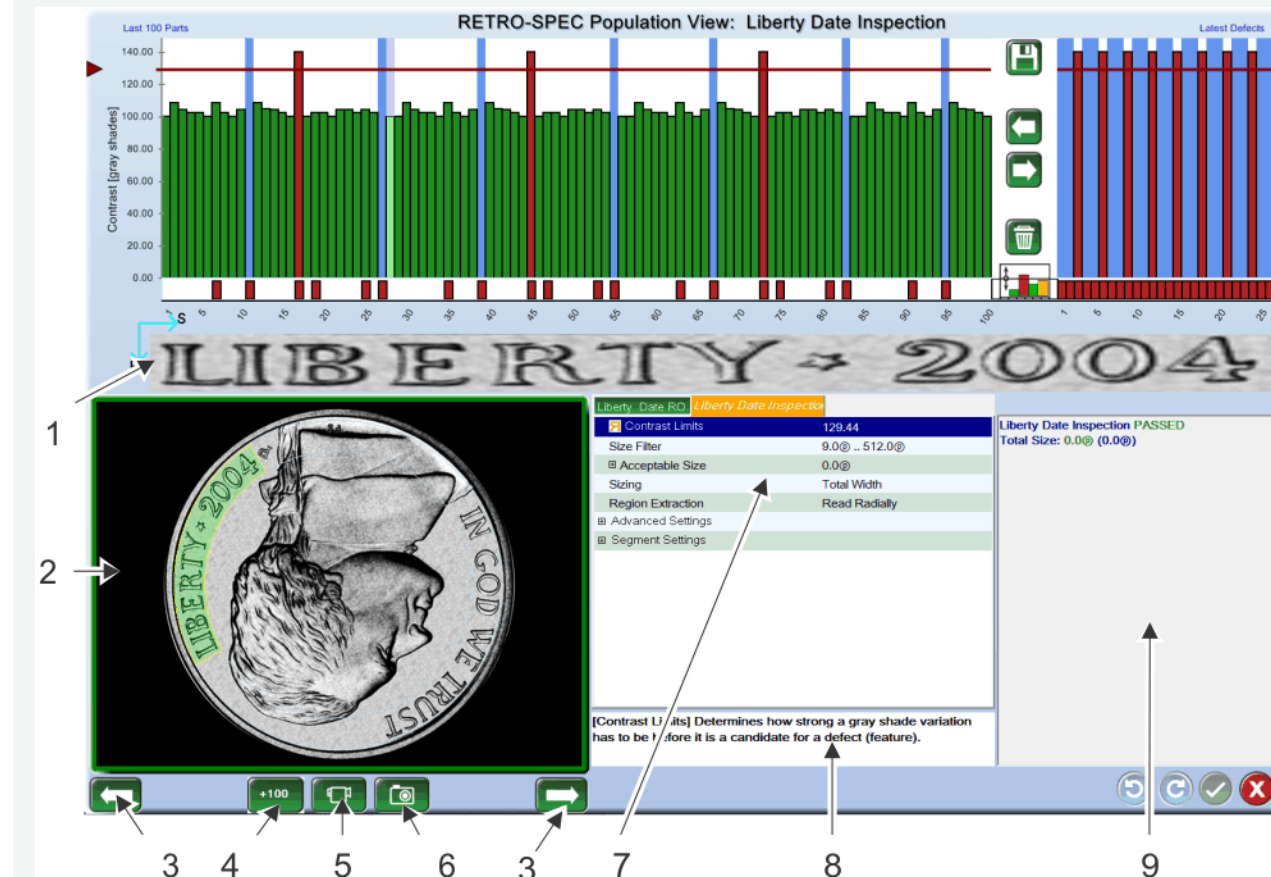

- 1 - Unwrapped region of interest (ROI)
- 2 - Part image
- 3 - Previous and next image
- 4 - Get 100 new images
- 5 - Refresh data set
- 6 - Snap one image
- 7 - Inspection parameters
- 8 - Parameter description window
- 9 - Results box

Edit Parameters

You can change options that will alter the outcome of an inspection. You must have user permissions to edit. Double-click the inspection name in the inspection tree to edit.

Ring	Radial Edge	Target Circle	Edge Location
Search Vector Count 105			
Search Direction		<input checked="" type="checkbox"/> Flipped	
Radial Tolerance		4	
Diagnostics			
Show Edges		<input checked="" type="checkbox"/> Enabled	
Reject Limits			
<input checked="" type="checkbox"/> Qualifying Percent Limits		46.88 .. 68.68	

- 1 - Inspection tabs
- 2 - Adjust numeric values
- 3 - Check box to enable or disable the feature
- 4 - Backwards R
- 5 - Column division

1 - **Inspection tabs** Select a tab to adjust parameters. The orange tab contains the parameters that can be adjusted with the bars on the Retro-Spec graph. The tabs depend on the inspection and its relationship within the inspection tree.

Adjust numeric values

Large Slider - Use a sliding bar. Changes are also applied to the red and yellow sensitivity bars in the Retro-Spec graph. If the parameter has an upper and lower limit, portions of the bar are displayed in different colors, as shown below:



Red = failure limit. A part value that falls in the red zone fails inspection.

Yellow = warning limit. A part value that falls in the yellow zone is tagged as a warning level part.

Green = passing. A part value that falls in the green zone passes (at least this parameter).

Numeric Text Entry - Type in a specific number. You can use the +1 and -1 feature to make minor adjustments.

4 - **Backwards R** The current parameter can be adjusted in the Retro-Spec graph (example: the red and yellow limits bars).

5 - **Column division** This line is not actually displayed. You can see Large Slider AND numeric entry pad if you select in the left column, or just the numeric entry pad if you select in the right column (this only applies if Numeric Input setting = both. See Editor Options).

Editor Options

Right-click over the parameters menu to see the Editor Options. ✓ = enabled

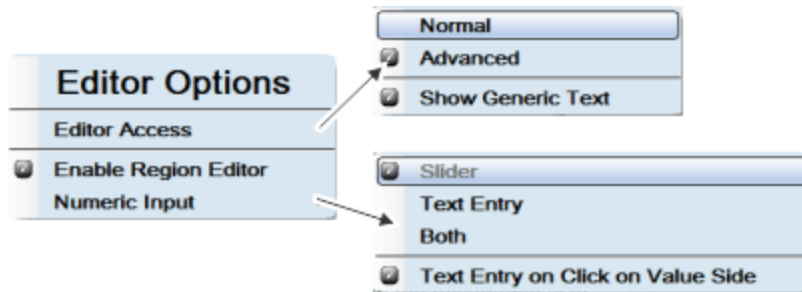

Editor Access

Normal - display the normal menus (for most users)

Advanced - display the advanced parameters (for power users)

you must have the appropriate permissions to see the advanced parameters: "Access advanced inspection parameters"

Show Generic Text - default Intellispec names.

Enable Region Editor Available when the inspection has an associated region that can be modified.

Numeric Input

Slider = Large Slider as described in ["Edit Parameters" on the previous page](#)

Text Entry = Numeric Text Entry

Both = both Large Slider and Numeric Text entry. After you make changes, select the OK button to close them.

Text entry on click on value side = if you select an item the right column of the menu, you will see only the Numeric Text Entry box, even if you have Both checked

Result Options

There is additional information for the Results Box. Right-click to see the menu. ✓ = enabled

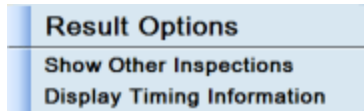

Show Other Inspections Shows whether a part passed or failed other inspections on the current sensor. Right-click the menu again to see the option to hide good inspections. Double-click any inspection to show the Retro-Spec graph and images for that inspection.

Display Timing Information Displays timing information for each inspection on the current sensor and the total time in milliseconds.

Retro-Spec Display

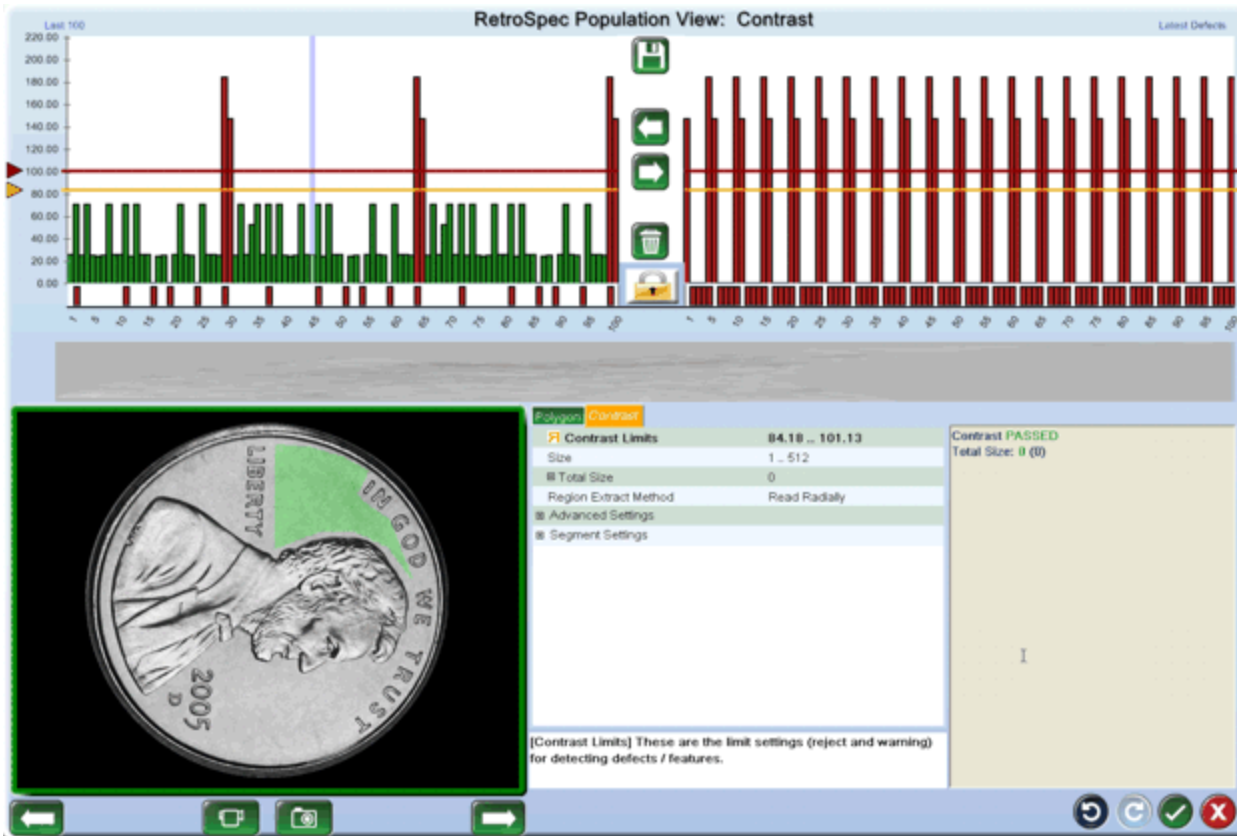

Double-click an inspection name in the inspection tree to see the Retro-Spec display. There are two views available for the graph area of the screen: "Retro-Spec Population View" on the next page and "Retro-Spec Part View" on page 166.

Retro-Spec Population View

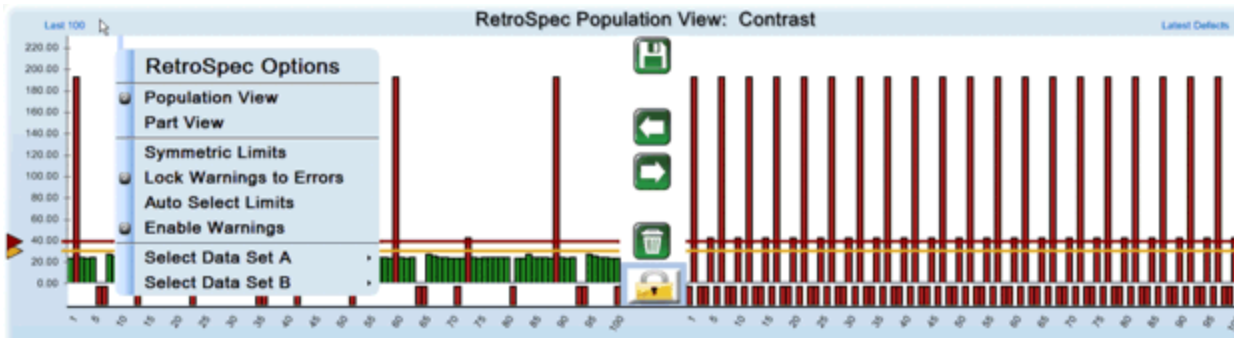

- Each peak is a different part. Red peaks are failed parts, green peaks are passed parts.
- The left side of the graph displays up to the last 100 parts that were inspected
- The right side of the graph displays up to the last 100 rejected parts
- Click on any peak to display the Part View for that part
- Right-click on the graph to select between the Part View and the Population View

Retro-Spec Options

Right-click the Retro-Spec graph to see the Retro-Spec options menu.

some options are not displayed if they are not applicable to the current inspection.

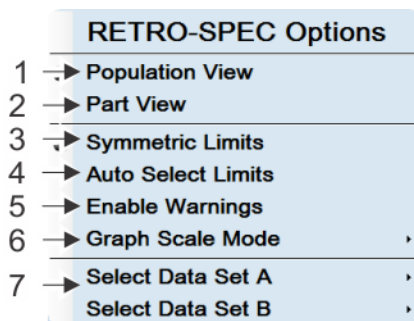

- 1 - **Population View** Display the Retro-Spec population view graph.
- 2 - **Part View** Display the Retro-Spec part view graph.

3 - **Symmetric Limits** When the Retro-Spec graph has upper and lower limits (two red bars and two yellow bars), this option keeps the upper and lower limits the same distance from nominal.

Lock Warnings to Errors [If warnings are enabled] Locks the yellow warning bar to the red reject bar in the Retro-Spec graph, keeping them the same distance apart.

4 - **Auto Select Limits** Automatically adjusts warning and reject levels to make all parts in the data set pass.

5 - **Enable Warnings** Provides a warning level (yellow) sensitivity bar. A warning does not reject parts, but indicates that the process is approaching the reject status. When you enable warnings, they are enabled for all inspections for the current sensor.

6 - **Graph Scale Mode** Change the height scale of the graph. **Limits Only** displays part parameter values up to and including the current inspection limits. This is useful when you want to zoom in on data without extra lines on the graph. Note that the limit lines may not be displayed on the graph. As soon as you change the parameter limits from the menu, the limit lines are displayed again on the graph. **Limits and Data** is the default mode that displays all the inspection data plus the limit lines.

7 - **Select Data Set A or B** For each Data Set, you can select what you want to display. You can choose files that have been previously saved to the computer. See information about Saving Images. See also Freeze on Defect Image in Retro-Spec.

[not shown] **Select Parameter** Choose a graph to display. This is available for some inspections, such as Measurement and BMID inspections.

Retro-Spec Part View



- The Part View displays a single part view. Each peak shows the contrast as the inspection moves from 0° (at left), to 360° (at right).
- Green peaks are acceptable; red peaks are where the contrast has exceeded limits.
- The height or amplitude of each peak reflects the amount of contrast (how dark or light change)
- The width of each peak reflects the physical size of the change (below the red peaks are the same width as the light and dark marks they represent)

1 - **Unwrapped region** - Below the graph is a display of the inspection region unwrapped. The degrees represent where the unwrapped region begins and ends.

2 - **Sensitivity slide bar** - This is the inspection's primary sensitivity parameter and is adjusted up (less sensitive) or down (more sensitive) by clicking on the bar or arrow at the left and dragging it to the desired position.

Unwrapped Region of Interest Options

Right-click in the Unwrapped Region of Interest to display this menu. ✓ = enabled

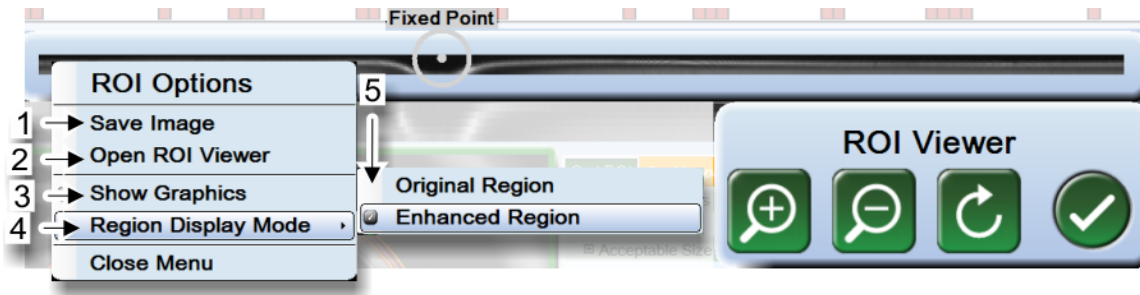

1 - Save Region of Interest Image

2 - **Open ROI Viewer** Display the unwrapped region at full resolution. Select a rotate button to change the orientation of the unwrapped ROI image.

3 - Show Graphics - no effect

4 - **Region Display Mode** Show the original region, or the enhanced region if you use an enhancement in the part program.

[not shown] **Region Selected** (Only available if the inspection has more than one region; example: Fill Height) Select which region to display.

Inspection Tree Relationships

The inspection tree shows the relationship of each inspection. Indented objects are dependent on the object above it. Some items in the menu may be turned off. The ability to access some items depends on your user access.



See also "Icon or Symbol Options (Sensor Menu)" on page 148

Part Program Change Log

The part program change log lists the inspections and the edit history for each. You can view all inspections from one sensor, other sensors, or other part programs. This is helpful if you want to see the previous settings for an inspection.

Part Program Change Log

Roll Back
 Show Other Inspections
 Show Other Part Programs
 Show Other Sensors

Inspection: Undefined
 Part Program: Measurement_test
 Sensor: Undefined

Type	Time Stamp	User	Camera/Sensor	Inspection	Parameter	Before	After
Create	2011-02-15 16:12:07	Administrator	Nickel	Ring			
Create	2011-02-15 18:12:19	Administrator	Nickel	Ring	Inner Radius	25	199
Edit	2011-02-15 18:12:49	Administrator	Nickel	Ring	Thickness	50	53
Create	2011-02-15 18:12:57	Administrator	Nickel	Radial Edge			
Edit	2011-02-15 18:13:36	Administrator	Nickel	Radial Edge	Target Size	100	230
Edit	2011-02-15 18:13:36	Administrator	Nickel	Radial Edge	Qualifying Percent Limits	E:25.0 W:W50.0 G	E:32.71 W:W47.91 G
Create	2011-02-15 18:13:56	Administrator	Nickel	Measurement			
Edit	2011-02-15 17:17:21	Administrator	Nickel	Measurement	Feature Type	Light Feature	Borders: Both Light
Edit	2011-02-15 17:17:21	Administrator	Nickel	Measurement	Inner Diameter.Enabled	No	Yes
Edit	2011-02-15 17:17:21	Administrator	Nickel	Measurement	Width.Enabled	No	Yes
Edit	2011-02-15 17:17:21	Administrator	Nickel	Measurement	Width.Units	pixel	Custom unit
Edit	2011-02-15 17:17:21	Administrator	Nickel	Measurement	Width.Nominal Value	53.0	26.5
Edit	2011-02-15 17:17:21	Administrator	Nickel	Measurement	Width.Min/Max	E:-50.0 W:W-10.0 G:[55555.0] G:0.0 W:W:0.0 E	E:-25.42 W:W-25.17 G:[26.5] G:0.0 W:W:0.77 E
Edit	2011-02-15 17:17:21	Administrator	Nickel	Measurement	Width.Average	E:-50.0 W:W-10.0 G:[55555.0] G:0.0 W:W:0.0 E	E:-26.5 W:W-26.5 G:[26.5] G:0.0 W:W:0.0 E
Edit	2011-02-15 17:17:21	Administrator	Nickel	Measurement	Width.Continuity	E:-50.0 W:W-10.0 G:10.0 W:W:50.0 E	E:-40.76 W:W-8.85 G:3.63 W:W:4.62 E
Edit	2011-02-15 17:17:21	Administrator	Nickel	Measurement	Width.Range	G:53.0 E	G:11.65 E
Create	2011-03-01 18:03:37	Administrator	Nickel	Clipping			
Edit	2011-03-01 18:05:17	Administrator	Nickel	Clipping	Use Clipping	No	Yes
Create	2011-03-01 18:05:26	Administrator	Nickel	Stretch Grayshades			

To view the part change log:

-  Go to Sensor Overview mode.
- Right-click over a sensor button or inspection name and select **Part Program Change Log** from the Inspection menu. If you right-clicked over an inspection name, and the current inspection has never been changed since it was set up, no data is displayed.
- Select any of the available check boxes to view other inspections, inspections from other part programs, or inspections from other sensors. Some boxes are dependent on others; for example, you must select a dark gray check box before a light gray check box becomes active.

To view a full column width, select and drag the column title to re-size that column.

Type	Time Stamp	User	Part Program	Inspection
Create	2010-08-20 08:26:29	Tricia	Penny1	

Optimize

The Optimize feature automatically sets the optimum settings for many inspection parameters. It is processor-intensive and must be done off-line. For this to work correctly, ensure that you have moved all acceptable images to the left side of the Retro-Spec graph (Set A), and the defect images to the right side of the graph (Set B). Optimize is available under the **Advanced Settings**.

To use the Optimize feature:

1. Make sure the Retro-Spec graph is in Population view: right-click on the graph to select Population View.
2. Load a set of good images into Data Set A

Next load a **set of images of bad parts** into Data Set B. These parts should have defects in the current inspection's region of interest.

To finish setting up the Optimize feature:

1. In the Contrast menu, choose the **Defect Type**: light, dark, or both.
2. Adjust the **Acceptable Size** parameter to catch the size of defect you want to detect.
3. Click the **Optimize** button. The system will analyze the part sets and determine the best settings to pass the good parts while failing the bad parts. Wait till the optimization process is complete - this may take several seconds.
4. Scroll through the images from the Retro-Spec graph to determine whether the good parts are still passing and the bad parts are failing. You should see good parts on the left side of the graph, and bad parts on the right side of the graph.
5. Test the inspection by loading more images. You can make slight adjustments in the Contrast menu if necessary.